

# **INSTRUCTION BOOKLET**

## **for the**

# **Abbreviated Joint Federal/State Application**

## **for the Alteration of any Tidal Wetland**

## **and/or Tidal Waters in Maryland**



Photo: Team SWAMP, University of Maryland

### **Maryland Department of the Environment**

### **Wetlands and Waterways Program**

Prepared by:



**US Army Corps  
of Engineers®**



**Maryland**  
Department of  
the Environment

**THIS PAGE INTENTIONALLY LEFT BLANK**

# Table of Contents

GUIDE AND INSTRUCTIONS FOR COMPLETING .....	2
WETLANDS & WATERS DELINEATIONS .....	3
PRE-APPLICATION MEETING SCHEDULING .....	3
Agency Use Only:.....	4
Pre-Application meeting: .....	4
Reason for application: .....	4
MDE required fees:.....	5
USACE authorizations:.....	8
Application Contact Information: .....	9
<b>1. APPLICANT INFORMATION:</b> (Please note that the applicant is not the contractor/agent applying on behalf of a property owner).....	9
<b>2. RIPARIAN PROPERTY OWNER INFORMATION:</b> (If different from the Applicant) .....	9
<b>3. AUTHORIZED AGENT / PRINCIPAL CONTACT INFORMATION:</b> .....	10
<b>4. CONTRACTOR INFORMATION</b> (If currently unknown, required to be provided to MDE’s Tidal Wetland Division prior to construction of project) .....	10
Project Description.....	10
Project Purpose .....	11
Project Location .....	11
U.S. Army Corps of Engineers federally authorized Civil Works Projects (USACE project):.....	12
Best Management Practices for Compliance with Endangered Species Act:.....	13
Notification to County Critical Area Commission and Buffer Management Plan: .....	17
Notification to Adjacent Contiguous Property Owners:.....	17
Project Planning and Design.....	17
Avoidance and Minimization Analysis:.....	18
Compensation: .....	18
Riparian Property Owner Certification:.....	20
APPLICATION SUBMISSION - IMPORTANT: .....	22
APPENDIX.....	A1
<b>ALTERNATIVE SIGNATURES FORM</b> .....	A2
<b>LIMITED POWER OF ATTORNEY</b> .....	A3
<b>CRITICAL AREA BUFFER NOTIFICATION FORM</b> .....	A4
<b>Living Shoreline Waiver Request</b> .....	A5



# GUIDE AND INSTRUCTIONS FOR COMPLETING

## The ABBREVIATED JOINT FEDERAL / STATE APPLICATION FOR THE ALTERATION OF ANY TIDAL WETLAND AND/OR TIDAL WATERS IN MARYLAND

The following instructions and information are designed to assist you in applying for permits or licenses from Federal and State agencies for work in tidal waters and/or tidal wetlands within the State of Maryland. The intent is to provide general information on the permit process, not to act as a complete legal and technical reference.

This Abbreviated Joint Permit Application (JPA) is used to apply for federal and State authorization under the Maryland State Programmatic General Permit (MDSPGP) for work in tidal waters of the U.S. (including tidal wetlands) from the Baltimore District U.S. Army Corps of Engineers and the Maryland Department of the Environment (MDE) within the State of Maryland.

Please refer to the current version of the United States Army Corps of Engineers (USACE) MDSPGP to determine the project limits and conditions that are eligible for authorization under the MDSPGP. Some activities that may be eligible to use the Abbreviated JPA include private piers, boat lifts, marina pier reconfiguration, boat ramps, maintenance dredging of previously authorized dredged areas, general maintenance activities, private landowner oyster gardening activities, toe protection for new or existing bulkheads, low-profile sills, and groins. Projects that do not meet the activity-specific impact limits and requirements of the current version of the MDSPGP must use the Standard Joint Permit Application.

New commercial\* shellfish aquaculture activities\*\* should use the Joint State/Federal Application for a Commercial Shellfish Aquaculture Lease and Federal permit. This is available for download at:

<http://dnr.maryland.gov/fisheries/Documents/Commercial-Shellfish-Lease-Application.pdf>

<http://www.nab.usace.army.mil/Missions/Regulatory/Aquaculture.aspx>

Instructions for the Commercial Shellfish Lease Application is available for download at:

<http://dnr.maryland.gov/fisheries/Documents/Shellfish-Lease-Application-Instructions.pdf>

\*Aquaculture activities proposed for any other purpose than commercial i.e. experimental, research, educational, etc. must apply for federal and State authorization using this Abbreviated JPA and submit the application to MDE. Applicable State application review fees shall be required.

\*\* Any structure (e.g., piers, upwellers, mooring pilings, work platforms, etc.) proposed and associated with the new commercial shellfish aquaculture activity must also apply for federal and State authorization for those structures using this Abbreviated JPA and submit the application to MDE. Applicable State application review fees shall be required.





Read the instructions carefully to determine how many application copies must be submitted to MDE, who acts as the clearinghouse for permit applications. Permit applicants may obtain paper copies of the Abbreviated JPA by downloading from the MDE website or by calling the Regulatory Services Coordination Office at 410-537-3762 or 1-800-876-0200. The abbreviated JPA is available for download at:

[http://mde.maryland.gov/programs/Water/WetlandsandWaterways/PermitsandApplications/Pages/tidal\\_permits.aspx](http://mde.maryland.gov/programs/Water/WetlandsandWaterways/PermitsandApplications/Pages/tidal_permits.aspx)

## WETLANDS & WATERS DELINEATIONS

**DO NOT USE THIS FORM** if you are requesting **a Jurisdictional Determination (JD) only** to determine the presence of jurisdictional waters of the United States, including wetlands regulated by USACE under Section 404 of the Clean Water Act and Sections 9 and 10 of the Rivers and Harbors Act. The identification and location of jurisdictional Waters of the United States including wetlands must be performed using a multi-parameter approach defined in Technical Report Y-87-1, Corps of Engineers Wetlands Delineation Manual, dated January 1987, and applicable supplemental guidance. Contact the Baltimore District USACE to obtain a delineation verification by referencing the Contact Information on the Baltimore District Corps regulatory webpage at:

<http://www.nab.usace.army.mil/Missions/Regulatory/Contacts.aspx>

Additional information on jurisdictional determinations may be found at:

<http://www.nab.usace.army.mil/Missions/Regulatory/JurisdictionalDeterminations.aspx>

## PRE-APPLICATION MEETING SCHEDULING

Pre-application meetings are strongly encouraged to assist riparian property owners and applicants in compiling accurate and complete information required as part of the application package. All applicants for proposed structural shoreline control projects are required to submit the Living Shoreline Waiver Request Form on Page 21 (2 copies) and an **MDE approved waiver**. A pre-application meeting will enable you to obtain the waiver, if granted, prior to submittal of the application package. The pre-application meeting can ensure that all the required information necessary for the plans is depicted and that all the regulated resources are properly identified. A complete application is processed more quickly than an application that requires additional or corrected information. The pre-application meeting request form may be found at:

<http://mde.maryland.gov/programs/Water/WetlandsandWaterways/Pages/PreApplicationIntroduction.aspx>

Professional consultants/technical contacts that are completing the application are expected to understand how to properly calculate and itemize permanent and temporary impacts by resource type. They are expected to have a thorough understanding of the laws, regulations, policies, and requirements needed to submit a complete application which includes plans for all proposed activities.



Agency Use Only:

Please leave the top grey section labeled, **FOR AGENCY USE ONLY**, blank. This section is to be filled out by the agencies when your application is received.

Pre-Application meeting:

If a meeting with MDE and/or the USACE was conducted, prior to submitting this application, regarding potential activities or resources on the parcel(s) or address named in this application, please indicate by checking the box next to the agency (ies) met with and provide the name of the reviewer(s) from the respective agency (ies). Please provide the Agency Interest Number (AI#), if you met with a reviewer from MDE and they provided you with that number.

Pre-Application Meeting Held? <input type="checkbox"/> with MDE <input type="checkbox"/> with USACE	AI#(if given):	*MAILING INSTRUCTIONS LOCATED ON 2 <sup>ND</sup> PAGE OF THIS APPLICATION*
Reviewer's Name(s):		

Reason for application:

Indicate by checking the appropriate box if the application is for authorization of a proposed project or a modification of an existing and currently active license. A State tidal wetland license that has expired shall not be modified and any proposed work will require a new application, appropriate fee, and the applicable State and federal authorizations.

Applying for:	<input type="checkbox"/> Authorization	<b>MDE APPLICATION REVIEW FEE REQUIRED:</b> PLEASE REFER TO THE MDE WEBSITE: <a href="http://mde.maryland.gov/programs/Water/WetlandsandWaterways/Documents/Fee-Schedule-July2017.pdf">http://mde.maryland.gov/programs/Water/WetlandsandWaterways/Documents/Fee-Schedule-July2017.pdf</a>
	<input type="checkbox"/> Modification	

An MDE Tidal Wetland authorization is active for 3 years from the date of issuance. The date of issuance can be found on the License. A modification to an active authorization does not extend the length of time that the authorization is active; a modified authorization will still expire 3 years from the date of the original authorization that is being modified. **MDE Tidal Wetland General License authorizations can be extended for an additional 3 years.** A request to extend an active License for an additional 3 years should be received no earlier than 6 months prior to expiration and no later than 1 month from expiration. If an authorization has expired than a new application including all applicable fees will be required.

The MDSPGP is authorized for a period of five years from the date of issuance. Please note that the construction period expires for individual projects verified/authorized by the MDSPGP when the MDSPGP expires, is suspended, or revoked, whichever date occurs sooner. It is incumbent for the public to remain informed of changes to the MDSPGP. The USACE will issue a public notice announcing the changes when they occur. Activities authorized under the MDSPGP that have commenced construction or that are under contract to commence construction, prior to the expiration, modification, or revocation date of the MDSPGP itself, will remain authorized, provided the activity is completed within 12 months of the date of the MDSPGP's expiration, modification, or revocation. This provision does not apply if a specific MDSPGP verification has been modified, suspended, or revoked.



**MDE required fees:**

MDE requires an **application review fee** to be submitted in conjunction with the submittal of all applications in order to process the application and forward it to the appropriate State reviewer(s) and forward the application to the USACE. Please be aware that the application review fee (with a copy of the front page of the application) is sent directly to the bank for processing. The bank sends notification to MDE only after it has processed the check through their system. The application review process does not begin until the bank notification is received by the Wetlands and Waterways Program’s Regulatory Services Division.

**Please note the separate addresses to send the complete application and plans and the appropriate fee and first page of the application below:**

<p><b>PLEASE MAIL SEVEN COPIES OF THE APPLICATION, SITE PLAN, AND VICINITY MAP (WITH PROJECT LOCATION PINPOINTED) TO:</b></p> <p>MDE/WATER AND SCIENCE ADMINISTRATION          REGULATORY SERVICES COORDINATION OFFICE          MONTGOMERY PARK BUSINESS CENTER – ST 430          1800 WASHINGTON BOULEVARD          BALTIMORE, MD 21230-1708          (410) 537-3762 OR 1-800-876-0200</p>	<p><b>SEND THE APPLICABLE APPLICATION FEE, ALONG WITH A <u>COPY OF THE FIRST PAGE OF THE APPLICATION TO:</u></b></p> <p>MDE          P.O. BOX 2057          BALTIMORE, MD 21203-2057          PCA: 13910 OBJ: 4142</p> <p>PLEASE REFER TO OUR WEBSITE  <a href="http://mde.maryland.gov/programs/Water/WetlandsandWaterways">http://mde.maryland.gov/programs/Water/WetlandsandWaterways</a>          FOR FURTHER INSTRUCTIONS.</p>
---	---

In general, proposed project(s) that are considered residential activities by the State require an MDE processing review fee of \$750.00 for an application for State authorization and an activity processing review fee of \$250.00 for an application to modify an existing active State license.

In General, proposed project(s) that are considered commercial activities by the State require an MDE processing review fee of \$1,500.00 for an application for State authorization and to modify an existing active State license. Additional processing fees based on project size for commercial activities are required.

Additionally, there are projects that are exempt from the full MDE processing fee, but still require a reduced processing fee. The fee tables are below:

**Wetlands and Waterways Program  
 Application Fee Schedule and Guidelines**

FEE EXEMPT PROJECTS (APPLICATION REQUIRED)	
WETLANDS AND WATERWAY PROGRAM	
TYPE OF ACTIVITY	
1.	Any activity proposed by the State, a municipal corporation, county, bi-county or multicounty agency.
2.	Performance of agricultural best management practices approved by a Soil Conservation District.
3.	Performance of forestry best management practices prepared by a registered forester and approved by a Soil Conservation District.
4.	Stream restoration, vegetative shoreline stabilization, wetland creation, or other project in which the primary effect is to enhance the State’s wetland or water resources.
5.	Aquaculture activities for which DNR has issued a permit under Title 4, Subtitle 11A of the Natural Resources Article.



**FEE SCHEDULE A**

-Fees are not additive; use the highest fee for the activity(ies) proposed-  
(If the proposed nontidal wetland and waterway activity is not listed in this table,  
then use FEE SCHEDULE C)

**NONTIDAL WETLAND AND WATERWAY PROJECTS**

ACTIVITY	ACTIVITY PARAMETERS	APPLICATION REQUIRED	APPLICATION FEE REQUIRED
Non-habitable structure (ex. driveways, decks, pools, sheds, or fences)	Permanent impacts ≤ 1,000 square feet	YES	\$300.00
In-kind repair and replacement of existing infrastructure in nontidal wetlands  (Infrastructure is defined as: the structures such as roads, bridges, culverts, utilities, etc. that supports the general public and do not meet the definition of a residential activity)		YES	\$500.00

**FEE SCHEDULE B**

-Fees are not additive; use the highest fee for the activity(ies) proposed-  
(If the proposed tidal wetland activity is not listed in this table, then use FEE SCHEDULE C)

**TIDAL WETLAND PROJECTS**

ACTIVITY	ACTIVITY PARAMETERS	APPLICATION REQUIRED	APPLICATION FEE REQUIRED
Replacement Bulkhead	Replacement bulkhead is proposed ≤ 18 inches channelward of the existing, functional <sup>(1)</sup> bulkhead	YES	\$500.00
Platform and/or finger pier	Platform	YES	\$300.00  (To meet the application fee total area of all proposed platform(s) and finger pier(s) is ≤ 200 square feet)
	Finger pier		
	Fixed or Floating on an existing functional <sup>(1)</sup> pier  Total area of all proposed platform(s) is ≤ 200 square feet <sup>(2)</sup>		
Mooring piles	≤ 6 <sup>(4)</sup>	YES	\$300.00
Boat lift/hoist or Personal Watercraft Lift	Installation of pilings associated with lift	YES	\$300.00
Installation of a boatlift or personal watercraft lift on existing pilings	No new outer piling to be installed	YES	<b>NO FEE</b> (No other activity is proposed)
Construction of a Living Shoreline <sup>(5)</sup>		YES	<b>NO FEE</b> (No other activity is proposed)
In-kind repair and replacement of functional structures located within jurisdictional tidal wetlands. <sup>(6)</sup>		NO	<b>NO FEE</b>

<sup>1</sup> “Functional” means performing at least 85 percent of the action that a structure was originally designed to perform (COMAR 26.24.01.02(20)).

<sup>2</sup> COMAR 26.24.04.02B(3). Total platform space of existing and proposed platforms must be ≤ 200 square feet.

<sup>3</sup> COMAR 26.24.04.02B(4)



<sup>4</sup> COMAR 26.24.04.02B(2)(c)(v)

<sup>5</sup> Construction of a Living Shoreline must be the only activity proposed on the application; otherwise the appropriate fee for the other proposed activities shall apply.

<sup>6</sup> Must adhere to the definitions found in COMAR 26.24.01.02B(20)(24)(45). No increase of width, length, or height of the existing, previously authorized or “grandfathered”, functional structure.

FEE SCHEDULE C		
ACTIVITIES NOT FEE EXEMPTED OR DESCRIBED IN FEE SCHEDULE A OR B	AREA OF IMPACT	APPLICATION FEE REQUIRED
MINOR PROJECT <sup>(1)</sup>	<5,000 SQUARE FEET	\$750.00
MAJOR PROJECT <sup>(2)</sup>	<1/4 ACRE	\$1,500.00
	≥ ¼ ACRE TO < ½ ACRE	\$3,000.00
	≥ ½ ACRE TO ≤ ¾ ACRE	\$4,500.00
	≥ ¾ ACRE TO < 1 ACRE	\$6,000.00
	≥ 1 ACRE	\$7,500.00/ACRE
MINOR MODIFICATION <sup>3</sup> (State Authorization has been issued and is currently active)	<5,000 SQUARE FEET	\$250.00
MAJOR MODIFICATION <sup>4</sup> (State Authorization has been issued and is currently active)	>5,000 SQUARE FEET	\$1,500.00

<sup>1</sup> **Minor projects** include the following:

1. Projects proposing to impact less than 5,000 square feet of wetlands, waterways, including the 100-year floodplain.
2. **A project that proposes residential activities:**
  - a. **Residential Activity** means a noncommercial activity that is conducted on residential property
    - i. **Residential Property** means improved property that is used primarily as a residence or unimproved property that is zoned for use as a residence. Includes:
      1. Property owned by a homeowner’s association
      2. A condominium
    - ii. A **Residential Property** does not include:
      1. A commercial building
      2. A marina
      3. A residential apartment complex or building
3. Mining Activities

<sup>2</sup> **Major Project** include the following:

1. A project that proposes to impact 5,000 square feet or more of wetlands or waterways, including the 100 year floodplain.
2. A nontidal wetland in an area of special state concern.
3. A project that requires public notice.



TIDAL WETLAND ACTIVITIES REQUIRING A PUBLIC NOTICE	
ACTIVITY	ACTIVITY PARAMETERS
New bulkhead	> 300 linear feet and/or > 10 feet channelward of the mean high water line
Replacement bulkhead	> 18 inches channelward of the existing bulkhead or > 10 feet channelward of the existing bulkhead when a stone toe protection is included
Revetment projects	> 500 linear feet and/or > 10 feet channelward of the mean high water line
Living shoreline/marsh creation	> 500 linear feet and/or > 35 feet channelward of the mean high water line
New stormwater discharge	Discharge within the critical area
Dredging projects	> 1,500 square feet and/or > 100 cubic yards of material
Boat ramp	> 12 feet wide and/or are > 30 feet channelward of the mean high water line
Groin, Jetty, Breakwater	
Any other activities substantially affecting tidal wetlands including as required by law	

**Please be aware the review process for your application does not begin until MDE receives the required processing fee(s) and 7 copies of a complete application which include plans.**

Reference the website below for more information concerning application fees:

<http://mde.maryland.gov/programs/Water/WetlandsandWaterways/Documents/Fee-Schedule-July2017.pdf>

**USACE authorizations:**

The Maryland State Programmatic General Permit (MDSPGP) may be issued in situations where a State authority has a regulatory program in place that provides a similar level of review as the USACE. In such cases, the MDSPGP avoids unnecessary duplication of effort by providing Corps authorization for certain activities with minimal adverse environmental effects, as specified by the terms, conditions, and limitations of the MDSPGP, provided they obtain the necessary state, regional, and local authorizations.

A proposed project which meets the MDSPGP – Category A activity-specific impact limits and requirements will have the JPA assigned a permit application number by MDE and will be reviewed, in most cases, by MDE only and the subsequent USACE authorization will be confirmed by MDE and available for download at MDE's website or the USACE website.

A proposed project which meets the MDSPGP – Category B or MDSPGP-Category A & B activity-specific impact limits and requirements will be reviewed by the Corps, MDE, resource agencies, and/or in certain cases the public to determine whether such activities are eligible for authorization under the MDSPGP. Upon receipt of an application that potentially qualifies for authorization under the MDSPGP-Category B or Category A & B, MDE will assign a permit application number to the JPA and will then distribute a copy of the application and plans to USACE. MDE and USACE will conduct separate but concurrent reviews of your project. Please be aware that MDE and the Corps will issue separate State and Federal authorizations for projects reviewed under the MDSPGP-Category B process. Therefore, please be sure that you have received all necessary authorizations, or documentation that no permit is required, prior to beginning the proposed work.

Permit application fees are not required for USACE MDSPGP verifications requested by this Abbreviated JPA



Application Contact Information:

**1. APPLICANT INFORMATION:** (Please note that the applicant is not the contractor/agent applying on behalf of a riparian property owner)

Name: \_\_\_\_\_ Telephone: (\_\_\_\_\_) \_\_\_\_\_  
Address: \_\_\_\_\_ Email Address: \_\_\_\_\_  
City: \_\_\_\_\_ State: \_\_\_\_\_ Zip: \_\_\_\_\_

**2. RIPARIAN PROPERTY OWNER INFORMATION:** (If different from the Applicant)

Name: \_\_\_\_\_ Telephone: (\_\_\_\_\_) \_\_\_\_\_  
Address: \_\_\_\_\_ Email Address: \_\_\_\_\_  
City: \_\_\_\_\_ State: \_\_\_\_\_ Zip: \_\_\_\_\_

**The riparian property owner is the entity which holds title or an enforceable claim to the waterfront land on which the project and associated activities are proposed and must be the applicant.** The riparian property owner is responsible for the activities conducted on the land parcel(s) listed in the application. Riparian property owners may be an individual person(s), partnership, Joint Stock Company, unincorporated association or society, trust, federal government, the State, any unit of the State, county, municipal organization, a political subdivision, or other corporation of any type. If the applicant/riparian property owner is an agency, company, corporation, or other organization, please indicate the company/organization name and the responsible officer and their title. Entities that hold an easement or right-of-way allowing them to conduct activities on the site should also complete this block.

**For an MDE authorization in tidal waters or tidal wetlands,  
the applicant must be the riparian property owner.**

However, USACE regulations recognize that the applicant can be either the riparian property owner or an entity (person/company/organization) that does not own the property but intends to undertake the activity. Applicants, if not the riparian property owner, must have a legal right to construct a project on the property. USACE, unlike MDE, can issue an authorization to an applicant other than the riparian property owner where the applicant has been given the legal right by the property owner to construct a project on the property. Applicants may include contract purchasers of the property. In such instances where the applicant and the property owner will be different, the application must be filled out according to the MDE requirement (applicant and property owner must be the same entity) and the ALTERNATIVE SIGNATURES FORM, located on page 18, should be filled out appropriately and submitted with the application package. The Alternative Signature Form will be forwarded to USACE. Please be aware that MDE will issue the State license to the Property Owner and USACE will issue to the Applicant.

Fill in the information for the applicant and/or the riparian property owner. The address should be the address where the applicant/owner receives mail through the United States Postal Service. The telephone number should be where the applicant (not the contractor or agent) may be reached during business hours.





**3. AUTHORIZED AGENT / PRINCIPAL CONTACT INFORMATION:**

Name: \_\_\_\_\_ Telephone: (\_\_\_\_\_)  
Address: \_\_\_\_\_ Email Address: \_\_\_\_\_  
City: \_\_\_\_\_ State: \_\_\_\_\_ Zip: \_\_\_\_\_

This is the person to whom correspondence will be addressed and has been designated by the applicant to represent him/her in this process. The individual should be the person most knowledgeable about the project and proposed activities and will be able to answer questions from regulatory agencies. Any questions or concerns about the proposed project, the status of the application, and plan revisions are to be performed by this individual or the applicant.

Fill in the information for the authorized agent/principal contact. The address should be where the agent/principal contact receives mail through the United States Postal Service. The telephone number should be where the agent/contact may be reached during business hours.

**4. CONTRACTOR INFORMATION** (If currently unknown, required to be provided to MDE's Tidal Wetland Division prior to construction of project)

Company Name: \_\_\_\_\_  
Principal Contact: \_\_\_\_\_ Email Address: \_\_\_\_\_  
Marine Contractor MDE License #: \_\_\_\_\_ Telephone: (\_\_\_\_)

If you are proposing a project in tidal waters or tidal wetlands and have identified a Marine contractor, provide the Maryland-Marine Contractor's Licensing Board's License number. Use of a licensed Marine contractor is required by MDE for authorized work in tidal wetlands or waters. Prior to beginning construction of any part of the project authorized by the State and federal licenses, the name, principal contact, e-mail address, license #, and telephone # of the Marine Contractor, licensed by the Maryland-Marine Contractor's Licensing Board who will be performing the work shall be provided to the Tidal Wetland Division.

Project Description

**5. PROJECT DESCRIPTION:** (Attach additional pages if necessary)

\_\_\_\_\_  
\_\_\_\_\_  
\_\_\_\_\_

The written description is an important part of the application. Provide a detailed, but brief description of the project and proposed activities in regulated tidal waters and wetlands, the dimensions of all proposed activities, the name of the waterway, and the construction technique (if applicable). Be sure to include how the construction site will be accessed, especially if clearing, grading, use of construction mats, or dredging will be required. If more space is needed, attach an extra sheet of paper marked Block 5.

Ex. "To construct a 6' wide by 130' long timber pier, a 10' long by 20' wide platform, 2 boat lifts with 4 associated boat lift piles, 4 mooring piles extending a maximum of 140' channelward of the mean high water line and to construct a stone revetment along 140' of eroding shoreline extending a maximum of 10' channelward of the mean high water line. Construction mats will be used within the first 10 feet of the shoreline to minimize impacts to some sparse near shore vegetation. Access to the site will be from a barge."



NOTE: All activities which the applicant plans to undertake which are reasonably related to the same project and for which a Department of the Army permit would be required should be included in the same permit application. The USACE, will reject, as incomplete, any permit application which fails to comply with this requirement. For example, a permit application for a marina will include dredging required for access as well as any fill and structures associated with construction of the marina.

**Project Purpose**

<b>6. PROJECT PURPOSE:</b> (Check all that apply)			
<input type="checkbox"/> Beach Nourishment	<input type="checkbox"/> Improve Navigable Access	<input type="checkbox"/> Shore Erosion Control	<input type="checkbox"/> Fill
<input type="checkbox"/> Create/Improve Infrastructure	<input type="checkbox"/> Create/Improve Habitat	<input type="checkbox"/> Erosion/Sediment Control	<input type="checkbox"/> Marina
<input type="checkbox"/> Other: (describe) _____	<input type="checkbox"/> Utility Installation	<input type="checkbox"/> Residential/Commercial Development	

Check the appropriate box that best fits the purpose of the proposed activities by the applicant at the project site.

Ex. – construction of a pier might be to improve navigable access to the property, construction of a revetment is control shore erosion, a living shoreline might be to control shore erosion and create/improve habitat, etc.

**Project Location**

<b>7. PROJECT LOCATION:</b> (If project site has no address, please include the lot # and/or nearest address with a clear description of the site)	
County: _____	Name of Waterway: _____
Site Address or Location: _____	
_____	Latitude: _____ Longitude: _____
Directions from nearest intersection of two state roads: _____	
_____	

Accurate information on a project’s location is vital for the timely review of your application. Reviewers often have difficulty in locating sites if directions are not clear. If a reviewer cannot locate the project site, the reviewer cannot perform a field visit to properly evaluate your proposed activity which could possibly delay the review and processing of your application.

Provide the name of the county where the applicant’s proposed project is located. Provide the name of the waterway the proposed project is located; if unnamed tributary or canal then provide the name of the waterway that the tributary or canal connects to:

Ex. Unnamed tributary of ABC River, or Unnamed canal of ABC Bay, etc.

Provide the street address including the city/town/municipality and zip code that the proposed project will be located. “Same” or any omissions will be considered an incomplete application. If the property is a lot without a street address, the parcel and map number from state tax records should be provided. The street address of neighboring parcels, if available, also aids in locating sites.



Provide the latitude and longitude of the proposed project. Please place the coordinates as close to the proposed project area on the applicant's property as possible. Latitude and longitude should be depicted in either Degrees, minutes, seconds, Decimal degrees, or degrees, decimal minutes.

Ex. (Degrees, minutes, seconds) 39°16'32.19"N / 76°38'39.72"W  
(Decimal degrees) 39.275693° / -76.644481°  
(Degrees, decimal minutes) 39°16.542'N / 76°38.672'W

Provide directions to the project site from the nearest intersection of two State roads.

Ex. South on Rte. 2 to intersection of Rte. 214, turn left on Rte. 214 to Brown's Store, turn right on gravel road across from store, go one mile to red barn and turn left on dirt road. Project is directly at the end of the dirt road.

If the project is in an undeveloped subdivision or property, clearly stake and identify property lines and location of the proposed project to aid the reviewers during field review of your application. Please indicate if there is an access road to the project and whether it is public or private and improved or unimproved.

If more space is needed, attach an extra sheet of paper marked Block 7.

Attach an 8 ½" by 11" copy of a detailed plan such as a USGS topographic map or street map showing the site location and project boundary, so that it may be located for inspection. Include an arrow indicating the north direction. A supplemental plan showing how the property is to be subdivided should also be provided.

U.S. Army Corps of Engineers federally authorized Civil Works Projects (USACE project):

**8. FEDERALLY AUTHORIZED CIVIL WORKS PROJECTS:** Is the project located in, on, or adjacent to a U.S. Army Corps of Engineers' federally authorized civil works project, structure, property, or easement (e.g., federal navigation channel, flood control levees, dams and reservoirs, lake property, etc.)?  Yes  No  
If yes, has a review pursuant to 33 U.S.C. 408 (Section 408) been initiated?  Yes  No

The U.S. Army Corps of Engineers has constructed many Civil Works projects across the Nation's landscape, including but not limited to, dams, levees, navigation projects, jetties, dams and reservoirs, and floodwalls. A separate review is required pursuant to 33 USC 408 (Section 408) when work will temporarily or permanently modify, alter, occupy, or use any USACE project. For many, but not all USACE projects, additional information is publicly available at:

Federal Navigation Channels: <http://www.nab.usace.army.mil/Missions/Civil-Works/Nav-Maps/>  
National Levee Database: <http://nld.usace.army.mil/egis/f?p=471:1:>  
Corps Lakes: <http://www.nab.usace.army.mil/Missions/Dams-Recreation/>

*Note: These sources currently do not contain all USACE projects located in the Baltimore District.*

Please indicate whether your project is located in, on, or adjacent to a USACE project by checking the "Yes" or "No" box in Block 8.

**If you check "Yes", please indicate whether processing of a Section 408 request has been initiated by checking the second "Yes" or "No" box in Block 8.**



## Best Management Practices for Compliance with Endangered Species Act:

**9. BEST MANAGEMENT PRACTICES VERIFICATION:** I verify that my project will meet all Endangered Species Act Best Management Practices applicable to work in tidal waters and wetlands as required by the MDSPGP (see Section VII.B.4.c.i-iii).

Yes     No     Unknown

*Refer to the application instructions and the MDSPGP for additional information regarding these Best Management Practices.*

Please indicate whether you have designed and will construct your project to meet these Endangered Species Act Best Management Practices by checking the "Yes", "No", or "Unknown" box in Block 9.

**If you check No or Unknown, review under MDSPGP Category B or alternate permit process is required.**

The following Best Management Practices are applicable to projects within tidal waters and tidal wetlands under the MDSPGP (Refer below and to the MDSPGP - Section VII.B.4.c.i-iii for additional information regarding these Best Management Practices).

### **Best Management Practices Applicable to Category A and Category B Activities within Tidal Waters and Wetlands:**

**i. Pile Driving for Category A Activities:** For the protection of listed species, pile driving methods must maintain noise level thresholds not to exceed 150 db re 1  $\mu$ Pa RMS or 206 db peak re 1  $\mu$ Pa and must meet **one** of the following conditions:

- (1) Plastic or concrete piles must be less than 12 inches when a cushioned impact hammer or vibratory hammer is utilized for installation.
- (2) Timber piles must be 10 inches or less when a vibratory hammer is utilized for installation.
- (3) Vinyl or timber sheet piles must be 24 inches or less in width, as measured from the outer edge of corrugation to the inner edge of corrugation, when a cushioned impact hammer or vibratory hammer is used.
- (4) Pile driving activities must be located within freshwater tributaries or within tidal or nontidal wetlands.
- (5) Piles of any size/type with any hammer method must be installed behind diversion structures or in the dry when the tide is out in the intertidal zone.
- (6) Piles of any size/type with any hammer method must be installed between November 30 and March 15.

**(Note:** Any pile driving activity that does not meet one of the conditions above must be reviewed by the Corps as a Category B activity or an alternate Corps permit review process, as appropriate.

**ii. Pile Driving for Category A and Category B Activities:** For Category A and Category B activities, pile driving must be initiated with a soft start each day of pile driving, building up power slowly from a low energy start-up over a 20 minute period to allow for fish and other wildlife to leave the area.

**iii. Sediment Disturbing Activities Time-of-Year Restriction for Category A and Category B Activities:** Sediment disturbing activities, which includes pile driving activities, are prohibited during the period April 1 through June 30 within all tidal waters of the Chesapeake Bay in Maryland and its tidal tributaries with salinity levels <6 ppt (**See Appendix B**) for the protection of shortnose sturgeon during early life stages in these waters.



## Project Activity Impacts:

**10. TYPE OF PROJECT** (check all that apply and provide all applicable information):  
**This abbreviated application should only be used for projects that are eligible for federal authorization under the Maryland State Programmatic General Permit (MDSPGP). Please refer to the MDSPGP for eligible activities.**

<b>Work Proposed</b>	Overall Length	Average Width	Volume of Fill Material	Total Area Impacted (Sq. Ft.)		Maximum Distance Channelward from Mean High Water Line (Ft.)	New Work	Maintenance/Repair	Work Started/Completed
	(Ft.)	(Ft.)	(cu. yards.)	Permanent	Temporary	(Ft.)			
<input type="checkbox"/> Bulkhead	_____	_____	_____	_____	_____	_____	<input type="checkbox"/>	<input type="checkbox"/>	<input type="checkbox"/>
<input type="checkbox"/> Revetment	_____	_____	_____	_____	_____	_____	<input type="checkbox"/>	<input type="checkbox"/>	<input type="checkbox"/> *
<input type="checkbox"/> Breakwater	_____	_____	_____	_____	_____	_____	<input type="checkbox"/>	<input type="checkbox"/>	<input type="checkbox"/> *
<input type="checkbox"/> Groins, Jetties, or Low Profile Sill	_____	_____	_____	_____	_____	_____	<input type="checkbox"/>	<input type="checkbox"/>	<input type="checkbox"/> *
<input type="checkbox"/> Living Shoreline (vegetated area)	_____	_____	_____	_____	_____	_____	<input type="checkbox"/>	<input type="checkbox"/>	<input type="checkbox"/> *
<input type="checkbox"/> Pier	_____	_____	_____	_____	_____	_____	<input type="checkbox"/>	<input type="checkbox"/>	<input type="checkbox"/> *
<input type="checkbox"/> Finger Pier	_____	_____	_____	_____	_____	_____	<input type="checkbox"/>	<input type="checkbox"/>	<input type="checkbox"/> *
<input type="checkbox"/> Platform	_____	_____	_____	_____	_____	_____	<input type="checkbox"/>	<input type="checkbox"/>	<input type="checkbox"/> *
<input type="checkbox"/> Pile(s) (#: _____) <input type="checkbox"/> Osprey	_____	_____	_____	_____	_____	_____	<input type="checkbox"/>	<input type="checkbox"/>	<input type="checkbox"/> *
<input type="checkbox"/> Boat Lift (including support piles)	_____	_____	_____	_____	_____	_____	<input type="checkbox"/>	<input type="checkbox"/>	<input type="checkbox"/> *
<input type="checkbox"/> Boat Ramp	_____	_____	_____	_____	_____	_____	<input type="checkbox"/>	<input type="checkbox"/>	<input type="checkbox"/> *
<input type="checkbox"/> Utility Line	_____	_____	_____	_____	_____	_____	<input type="checkbox"/>	<input type="checkbox"/>	<input type="checkbox"/> *
<input type="checkbox"/> Construction Access/Mats	_____	_____	_____	_____	_____	_____	<input type="checkbox"/>	<input type="checkbox"/>	<input type="checkbox"/> *
<input type="checkbox"/> Dredging (Maintenance or New Minor)	_____	_____	_____	_____	_____	_____	<input type="checkbox"/>	<input type="checkbox"/>	<input type="checkbox"/> *
<input type="checkbox"/> Hydraulic / <input type="checkbox"/> Mechanical	_____	_____	_____	_____	_____	_____	<input type="checkbox"/>	<input type="checkbox"/>	<input type="checkbox"/> *
<input type="checkbox"/> Other:	_____	_____	_____	_____	_____	_____	<input type="checkbox"/>	<input type="checkbox"/>	<input type="checkbox"/> *

\* For any work started or completed, please clearly and accurately depict those portions of the project on the plans

**PLEASE NOTE:**

Please be advised that for ALL shore erosion control projects, a riparian property owner must obtain a State tidal wetlands authorization and all other applicable Federal, State, or local authorizations before beginning construction.

To obtain a State tidal wetlands authorization to construct a shore erosion control project, a riparian property owner must complete the following documents and submit them to MDE:

- a) A **Joint Federal/State Application for the Alteration of any Tidal Wetland in Maryland;**
- b) A proposed **Critical Area Buffer Management Plan;**
- c) A **Critical Area Buffer Notification Form** (Page A4);
- d) A **Living Shoreline Waiver Worksheet** (Page A5)\*; and
- e) If applying for a structural shoreline stabilization method, a **Living Shoreline Waiver approved by MDE.**

\*A completed Living Shoreline Waiver Request Form is not authorization of your proposed project or authorization to begin work.



Living Shoreline proposals - the parameters entered (i.e. length, width, total area impacted, and maximum distance channelward) should only include the actual area that will be filled with sand and vegetation and should not include any areas that will be filled with containment structures such as groins, low profile sills, fiber logs, etc. The containment structures should be shown in the appropriate work type (i.e. groins/jetties in that box, breakwater in that box, etc. Low profile sills and fiber logs should be shown in the “Other” box, writing in the work type, with their impacts appropriately identified.

Ex.

	Work Proposed	Overall Length	Average Width	Volume of Fill Material		Maximum Distance Channelward from Mean High Water Line	New Work Maintenance/Repair	Work Started/Completed	Work Proposed	Overall Length
<input checked="" type="checkbox"/>	Other: Low profile sill	452'	8'	540	3616	4520	35'	<input checked="" type="checkbox"/>	<input type="checkbox"/>	<input type="checkbox"/> *

Dredging ((Maintenance or New Minor) Minor dredging is defined as dredging which must not exceed 1,500 square feet in area and the volume of material removed must not exceed 100 cubic yards of material)) proposals - Identify the name and location of the proposed dredged material placement (DMP) site and the method of handling and disposing of, including transportation of, the dredged material. Separate plan sheets showing the location of the DMP site and area the material will be placed should be included with application. Include an acceptance letter from the DMP site owner or administrator specifically specifying the amount of material to be accepted and from the specific project with your application. Additionally, a currently approved Sediment and Erosion Control Plan will be required for a previously approved DMP site.

Minimum Setbacks for Structures Along Federally Authorized Channels: All applications seeking authorization for the construction of structures to be located along federally authorized navigation channels within the Baltimore District Civil Works Boundary will be required to supply latitude and longitude coordinates for the most channelward points of the proposed structure and any existing nearby structures. Currently, the latitude and longitude coordinates must be determined utilizing the current 1983-2001 NTDE. The Corps may require an updated NTDE to be used in the future. Additionally, all approved projects will be required to submit as-built latitude and longitude coordinates for review and approval by the Corps' Regulatory Branch. Additionally, all applications seeking authorization for the construction of structures to be located along federally authorized navigation channels within the Baltimore District Civil Works Boundary will be required to supply a bathymetric survey of the location of the structure. The survey must show actual water depths referenced to MLLW and clearly identify the 3-foot depth contour. See the Baltimore District Minimum Setback Guidance for Structures along Federally Authorized Channels for further information regarding the required parameters for submittal of latitude and longitude coordinates in a horizontal survey and requirements associated with a bathymetric survey. This document can be viewed on the Baltimore District Regulatory website at:

<http://www.nab.usace.army.mil/Mission/Regulatory/PublicationsandLinks.aspx>

All Projects: Provide accurate description of the length and width dimensions of the impact from each proposed structure or regulated activity.

Provide the permanent and temporary square footage that each activity will impact within regulated tidal wetlands. Although the USACE differentiates between permanent and temporary impacts in tidal wetlands, please be aware that **MDE’s Tidal Wetlands Division does not and considers all impacts to**



**regulated tidal wetlands as permanent.** The State and federal authorizations will be conditioned to restore all “temporarily” impacted areas to their original contours.

Provide the maximum distance channelward from the mean high water line (MHWL) to the end of the proposed activity. Channelward is considered the direction toward the water extending beyond the MHWL.

MHWL means the line where the land meets the water surface at the elevation of mean high water (MHW); and MHW means the average of all the high water levels observed over the national tidal datum epoch (19-year period of water level averaging)). Under State regulations, COMAR 26.24.02.02E(2), MHW may be determined using one of the following methods:

- (a) Control tide station data as published by the U.S. Department of Commerce, National Oceanic and Atmospheric Administration; or
- (b) Derivation of the equivalent high water datum using a comparison of observational records with control tide station data as published by the U.S. Department of Commerce, National Oceanic and Atmospheric Administration; or
- (c) An evaluation of the project site conditions based upon the following parameters:
  - (i) Predicted tide range elevations,
  - (ii) Metrologic conditions,
  - (iii) Vegetation and other biological factors at the site including barnacles and algae lines, and
  - (iv) Physical indicators at the site such as rack lines, stain marks on nearby structures, and beach particle sorting.

Check the boxes indicating whether each proposed activity is new work, maintenance and repair to previously authorized functional structures, or work that has been started or completed prior to submitting the application. Any work that has been started or completed prior to submitting an application will be forwarded to the MDE’s Compliance Division and the USACE’s Regulatory Branch for further review. \* Any work started or completed must be clearly and accurately depicted differently on the plans from those portions of the work proposed.

Depth soundings across the waterway and at increments designated by the Corps project manager MAY be required for some proposed projects in shallow water tidal areas and as determined by the MDE and/or Corps project manager. Typically, 10-foot increments, the date and time the measurements were taken, and how they were taken (e.g., tape, range finder, etc.) is required. Please note: Proposed work that would extend a private pier greater than 25% of the width of the waterway channelward of the MHWL and/or vegetated tidal wetlands does not meet the MDSPGP and the Standard JPA must be used to apply for authorization of this work.

A description of the material to be discharged and amount of each material in cubic yards to be discharged within waters of the United States, including jurisdictional wetlands must be provided in the application for boat ramps, bulkhead repair or replacement, new minor dredging, maintenance dredging of previously authorized dredged areas, dry fire hydrants, and small weirs and flumes, Please be sure this description will agree with your drawings. Discharge material includes: rock, sand, clay, concrete, etc.





## Description of temporary vs. permanent impacts.

It is essential that accurate information about the extent of permanent or temporary impact be provided in the application. The extent of impacts determines what additional information, fees, public notice, and mitigation requirements apply to your project. Inaccurate calculation of impacts is a common error that results in delay in processing and requests for additional information.

Furthermore, it is important to distinguish between temporary and permanent impacts, as requirements, thresholds, and types of authorization may vary. It is additionally important that the acreage/square feet of impact shown match between plans and application.

## Notification to County Critical Area Commission and Buffer Management Plan:

**(All proposed shoreline erosion control projects) - A complete application shall also include:**

- 2 copies of a completed Critical Area Buffer Notification Form\* (Page A4).

[http://mde.maryland.gov/programs/Water/WetlandsandWaterways/Documents/www.mde.state.md.us/assets/document/wetlandswaterways/Buffer%20Notification%20Form%202-1-13%20%20\\_2\\_.pdf](http://mde.maryland.gov/programs/Water/WetlandsandWaterways/Documents/www.mde.state.md.us/assets/document/wetlandswaterways/Buffer%20Notification%20Form%202-1-13%20%20_2_.pdf)

- 2 copies of a proposed Critical Area Buffer Management Plan\*

<http://dnr.maryland.gov/criticalarea/Pages/buffer.aspx>

\* A riparian property owner must submit to MDE in order to obtain the State authorization to construct a shore erosion control project.

## Notification to Adjacent Contiguous Riparian Property Owners:

Notification of the waterfront property owners directly adjacent to the applicant's property, applicable Home Owner's Association, and applicable local officials must occur concurrently with the submittal of the JPA on all proposed pier projects including any related structures (i.e. boat lifts/hoists, PWC lifts/hoists, platforms, finger piers, pilings etc.) in tidal waters. Please fill out the Adjoining Riparian Property Owner, Homeowners Association, and Appropriate Local Official Notification Certification Form. Contact MDE for guidance on when the notification is needed for other applications.

## Project Planning and Design

### **11. DESCRIPTION OF AVOIDANCE, MINIMIZATION, AND COMPENSATION:**

Please be advised that unavoidable losses of tidal wetlands and/or aquatic resources may require compensatory mitigation. Please provide a separate sheet(s) that addresses the proposed project's avoidance, minimization, and compensation (if required) which includes any clearing, grading, or excavation required before, during, and after the project.

Wetlands, their buffers, tidal waters, waterways are sensitive resources providing many valuable benefits. An applicant under Title 26: Department of the Environment, Subtitle 24: Tidal Wetlands, Chapter 01, Section .01 (COMAR 26.24.01.01) and the requirements of the MDSPGP shall design a project to first avoid and then minimize the loss of tidal wetlands and waters. All applicants are expected to avoid these resources where practicable, or, if not practicable, reduce the adverse impacts as much as possible. Applicants are required to describe how impacts were reduced and why further reductions are not feasible; what constraints, if any, exist to prevent reduction of impacts; and what attempts were made to overcome constraints to reduction of impacts. More documentation may be required.



### Avoidance and Minimization Analysis:

Applicants should design projects and conduct regulated activities so as to have the least impact on regulated resources. The list of actions shown below include, but is not limited to, common avoidance and minimization actions that are required as part of the process that agencies follow in determining whether or not regulatory standards are met and an authorization can be granted:

1. Reduce the size of the project.
2. Re-design or re-configure the project, including shifting the location of the proposed structures.
3. Propose an activity that increases the amount of regulated resource.
4. Use different construction techniques or materials.
5. Install additional erosion and sediment control measures, including daily stabilization of disturbances.

If an applicant states that certain constraints prevent further avoidance and minimization, authorizing agencies require documentation indicating that attempts were made to overcome the constraint. Constraints may include cost, local design standards, health/safety requirements, and other natural resources concerns. For example, a local government may have design requirements that differ from what State or federal agencies request. In the case of a conflicting local requirement, MDE and/or the U.S. Army Corps of Engineers require correspondence from the local agency stating the requirement be provided, as well as evidence that the applicant attempted to receive a waiver/variance from the local government for the requirement. **Financial information for alternatives is required if a cost constraint is claimed, however, a more expensive alternative may still be required by regulatory agencies if the project can still be accomplished in a manner less harmful to wetland and water resources.** The expense of compensatory mitigation to offset impacts to aquatic resources should be considered in any evaluation of alternatives based on cost.

Please be advised that unavoidable losses of tidal wetlands and/or aquatic resources may require compensatory mitigation in accordance with the requirements of State COMAR and the MDSPGP.

### Compensation:

“Mitigation” refers to the compensation required when there is a permanent loss of a regulated resource. For vegetated wetlands, the compensation requirement is usually to replace the wetlands that are lost. Mitigation requirements are listed in COMAR 23.02.04.11. Federal regulations governing compensatory mitigation for activities authorized by permits issued by the USACE are outlined in the Final 2008 Mitigation Rule found here:

[http://www.usace.army.mil/Missions/CivilWorks/RegulatoryProgramandPermits/mitig\\_info.aspx](http://www.usace.army.mil/Missions/CivilWorks/RegulatoryProgramandPermits/mitig_info.aspx)

For vegetated wetlands, mitigation is the replacement of wetland acreage, functions and human values that were or will be lost, due to filling, excavation, changes to hydrologic regimes or any other activity that may degrade or destroy an existing wetland.



Maryland State COMAR (COMAR 23.02.04.11B) regulations require the following mitigation ratios:

Restoration or In-Kind Creation

1. Open water tidal wetlands – 1:1
2. Emergent tidal wetlands-2:1
3. Scrub-shrub tidal wetlands-2:1
4. Forested tidal wetlands-2:1
5. Tidal wetlands habitat for rare, threatened, or endangered species, or species in need of conservation-3:1
6. Submerged aquatic vegetation and natural oyster bars-3:1

Enhancement or Out-of-Kind Creation

1. Open water tidal wetlands-2:1
2. Emergent tidal wetlands-4:1
3. Scrub-shrub tidal wetlands-4:1
4. Forested tidal wetlands-4:1
5. Tidal wetlands habitat for rare, threatened, or endangered species, or species in need of conservation-6:1
6. Submerged aquatic vegetation and natural oyster bars-6:1

The Board of Public Works may require mitigation by conditioning the license on restoring, creating in-kind new tidal wetlands, creating out-of-kind new tidal wetlands, or enhancing existing tidal wetlands, or a combination; or monetary compensation in lieu of mitigation in an amount the Board determines appropriate. Compensation in lieu of mitigation received is deposited into the Tidal Wetlands Compensation Fund.

In accordance with the 2008 Mitigation Rule, the final compensatory mitigation plan will be required prior to commencement of impacts to waters and/or wetlands on your project site when impacts are authorized under the MDSPGP. If no mitigation is planned, submit a detailed statement with the application explaining the reason(s) that mitigation should not be required for the proposed impacts.

Generally, compensatory mitigation for the construction of open pile supported structures such as piers, elevated walkways, and wharves within tidal waters and wetlands is not routinely required. However, measures should be considered to the maximum extent practicable to minimize damage to the marsh surface and vegetation when locating and constructing the open-pile structure. For example, the elevated walkway should be aligned for the shortest practicable crossing of a marsh. Please consult with the State and the Corps reviewers prior to submittal of the application to determine if any proposed activity will require compensation to the State and/or Corps. This can be done at a pre-application meeting or by contacting them directly by telephone.



## Riparian Property Owner Certification:

### **12. STATE CERTIFICATION AND FEDERAL PRIVACY ACT STATEMENT:**

Application is hereby made for a permit or permits to authorize the work described in this application. I hereby designate and authorize the agent named above to act on my behalf in the processing of this application and to furnish any information that is requested. I certify that the information on this form and on the attached plans and specifications is true and accurate to the best of my knowledge and belief. I understand that any of the agencies involved in authorizing the proposed works may request information in addition to that set forth herein as may be deemed appropriate in considering this proposal. I grant permission to the agencies responsible for authorization of this work, or their duly authorized representative, to enter the project site for inspection purposes during working hours. I will abide by the conditions of all permit(s) or license(s) if issued and will not begin work without the appropriate authorization. I also certify that the proposed works are consistent with Maryland's Coastal Zone Management Plan.

Authorities: Rivers and Harbors Act, Section 10, 33 USC 403; Clean Water Act, Section 404, 33 USC 1344; Marine Protection, Research, and Sanctuaries Act, Section 103, 33 USC 1413; Regulatory Programs of the Corps of Engineers, 33 CFR 320-332. Principal Purpose: Information provided on this JPA will be used in evaluating the application for a permit. Routine Uses: This information may be shared with the Department of Justice and other federal, state, and local government agencies, and the public and may be made available as part of a public notice. Submission of requested information is voluntary, however, if information is not provided, the permit application cannot be evaluated nor can a permit be issued.

All information, including permit applications and related materials, submitted to MDE may be subject to public disclosure consistent with the Maryland Public Information Act, §4-101 et seq., General Provisions Article of the Maryland Code.

**I am the riparian property owner/applicant and do not want to be contacted by MDE.** All correspondence should occur with my authorized agent /principal contact designated in **Section 3**, located on the 1st page of this application. (By checking the box, you are acknowledging that you will not receive any correspondence directly from MDE ). I understand a copy of MDE's final decision regarding this application will be sent to me. This opt-out option does not apply to the U.S. Army Corps' correspondence, which will continue to be with the applicant/permittee.

**RIPARIAN PROPERTY OWNER MUST SIGN: \_\_\_\_\_ Date \_\_\_\_\_**

Refer to the **Application Contact Information** at the beginning of this instruction booklet regarding who is required to sign Block 12 of the JPA. For MDE, Block 12 must be signed by the **riparian property owner** (Block 2 of the JPA) who must also be considered the applicant (Block 1 of the JPA). For the USACE review, the Alternative Signatures Form (Page A2) must be used when there is an applicant who is not also the riparian property owner. The Alternative Signatures Form will be provided to USACE.

Please read the State and federal certifications carefully. The property owner must sign and date this section. **Any application which is not signed by the riparian property owner will be considered incomplete and shall delay the start of the review process. If there are multiple riparian property owners, each must sign the application.**

### *Riparian Property Owner/Applicant Correspondence "opt-out" Designation*

During the course of reviewing the application, MDE and the U.S. Army Corps', will direct correspondence relating to the review of the application with the principal contact listed in Block 3 and/or the Riparian Property Owner/Applicant listed in Block 1 and/or Block 2.

The riparian property owner may choose that all MDE correspondence regarding the review of the application is to be directed to the principal contact listed in Block 3 only. If the riparian property owner/applicant wants to forgo receiving correspondence relating to the application review then the riparian property owner/applicant should initial the box after carefully reading the paragraph following the initialization box.

**NOTE: This opt-out option does not apply to the U.S. Army Corps' correspondence, which will continue to be with the applicant/permittee. Additionally, a copy of the final MDE authorizations shall be mailed to the applicant/permittee.**



The U.S. Army Corps' regulations require direct communication with the applicant to whom the permit is issued and will be responsible for permit conditions that could include long-term obligations. Additionally, the permittee is responsible for all work performed by their contractors and this communication provides assurances that the applicant is aware of all representations made on their behalf.

This signature shall be an affirmation that the party applying for the authorizations possesses the requisite property rights to undertake the activity applied for (including compliance with special conditions, mitigation, etc.). This signature also serves as a "Right of Entry" to access the property for purposes of pre-project inspections and post-project inspections. During the JPA review process, site inspections will be necessary to evaluate a proposed project. Failure to allow an authorized representative of MDE and USACE to enter the property, or to take photographs of conditions at the project site, may result in the withdrawal of your permit application. The signature will also affirm that the party applying for the authorizations has read the "opt-out" correspondence paragraph and has "opted-out" by initializing the box or, by default, "opted-in" by not initializing the box and thus may receive correspondence.

Examples:

In the example below, the applicant will not receive correspondence from MDE except for a copy of the Department's final agency action (i.e. approval or denial) because they have initialed the box:

I am the riparian property owner/applicant and do not want to be contacted by MDE. All correspondence should occur with my authorized agent /principal contact designated in **Section 3**, located on the 1<sup>st</sup> page of this application. (By initializing the box, you are acknowledging that you will not receive any correspondence directly from MDE ). I understand a copy of MDE's final decision regarding this application will be sent to me. This opt-out option does not apply to the U.S. Army Corps' correspondence, which will continue to be with the applicant/permittee.

In the example below the applicant will receive correspondence from all agencies because they have left the box blank:

I am the riparian property owner/applicant and do not want to be contacted by MDE. All correspondence should occur with my authorized agent /principal contact designated in **Section 3**, located on the 1<sup>st</sup> page of this application. (By initializing the box, you are acknowledging that you will not receive any correspondence directly from MDE ). I understand a copy of MDE's final decision regarding this application will be sent to me. This opt-out option does not apply to the U.S. Army Corps' correspondence, which will continue to be with the applicant/permittee.

On occasion an agent/contractor/applicant's representative needs to use a Power of Attorney (POA) in order to obtain the required permits necessary for a proposed project. Please be aware that the STATE CERTIFICATION AND FEDERAL PRIVACY ACT STATEMENT language needs to appear on the POA provided in the application. An example of an acceptable POA is provided at the end of the instructions booklet (Page A3). **Any POA that does not have the riparian property owner acknowledging with their signature the STATE CERTIFICATION AND FEDERAL PRIVACY ACT STATEMENT will result in the application being considered incomplete.**



## APPLICATION SUBMISSION - IMPORTANT:

<p><b>PLEASE MAIL SEVEN COPIES OF THE COMPLETE APPLICATION AND PLANS (INCLUDING REQUIRED SITE PLAN AND VICINITY MAP (WITH PROJECT LOCATION PINPOINTED)) TO:</b></p> <p>MDE/WATER MANAGEMENT ADMINISTRATION REGULATORY SERVICES COORDINATION OFFICE MONTGOMERY PARK BUSINESS CENTER – ST 430 1800 WASHINGTON BOULEVARD BALTIMORE, MD 21230-1708 (410) 537-3762 OR 1-800-876-0200</p>	<p><b>SEND THE APPLICABLE APPLICATION FEE, ALONG WITH A <u>COPY OF THE FIRST PAGE OF THE APPLICATION</u> TO:</b></p> <p>MDE P.O. BOX 2057 BALTIMORE, MD 21203-2057 PCA: 13910 OBJ: 4142</p> <p>PLEASE REFER TO OUR WEBSITE <a href="http://mde.maryland.gov/programs/Water/WetlandsandWaterways">http://mde.maryland.gov/programs/Water/WetlandsandWaterways</a> FOR FURTHER INSTRUCTIONS.</p>
---	--

**Please take notice that the address to submit 7 copies of the application and required plans is different from the address to submit the 1<sup>st</sup> page of the application and the applicable fee.** The fee is delivered directly to the bank contracted by the State through the P.O. Box. The bank processes the received fee, matches the fee to the 1<sup>st</sup> page of the application, and notifies the Wetlands and Waterways Program of delivery after processing the check. Again, please be aware that the bank sends notification to MDE only after it has processed the check through their system. The application review process does not begin until the bank notification is received by the Wetlands and Waterways Protection Program's Regulatory Services Division. Delivery of the fee directly to MDE offices in person or by mail will result in a significant delay to the start of the review process because the check will have to be matched to an application and sent over to the bank for processing. Please check to make sure you have addressed the application packet and the fee packet correctly to avoid a delay in the review process.

### **A complete application\* shall include:**

- 7 copies of a completed and signed JPA
  - 7 copies of a complete set of plans with all required information (Refer to sample activity guidelines and drawings)
  - 7 copies of any required forms for the specific proposed activity i.e. Adjoining Riparian Property Owner and Appropriate Local Official Notification and Certification Form, etc.
  - MDE required review fee (amount dependent on proposed activity)
- \* Please collate the required JPA, plans, and forms so that there are 7 independent sets of the required information.

### **(All proposed shoreline erosion control projects) - A complete application shall also include:**

- 2 copies of a completed Critical Area Buffer Notification Form\* (Page A4).
- [http://mde.maryland.gov/programs/Water/WetlandsandWaterways/Documents/www.mde.state.md.us/assets/document/wetlandswaterways/Buffer%20Notification%20Form%20202-1-13%20%20\\_2\\_.pdf](http://mde.maryland.gov/programs/Water/WetlandsandWaterways/Documents/www.mde.state.md.us/assets/document/wetlandswaterways/Buffer%20Notification%20Form%20202-1-13%20%20_2_.pdf)
- 2 copies of a proposed Critical Area Buffer Management Plan\*
  - <http://dnr.maryland.gov/criticalarea/Pages/buffer.aspx>
- 2 copies of a completed Living Shoreline Waiver Request Form\* (Page A5).  
<http://mde.maryland.gov/programs/Water/WetlandsandWaterways/Documents/www.mde.state.md.us/assets/document/wetlandswaterways/Living%20Shoreline%20Waiver%20Request%20Form%20with%20Samples.pdf>
- 2 copies of the **MDE approved Waiver Letter\***

\* A property owner must submit to MDE in order to obtain the State authorization to construct a shore erosion control project.





## PROJECT DRAWINGS

Four types of illustrations are needed to properly depict the work to be undertaken. These illustrations or drawings are identified as a Vicinity Map, an Existing Plan View, a Proposed Plan View, and a Typical Cross-Section Map. Identify each illustration with a figure or attachment number.

- Vicinity Map (USGS topographic map, road map, or similar map showing project location)
- Existing Plan View Drawing (overhead, to scale or with dimensions clearly marked)
- Proposed Plan View Drawing (overhead, to scale or with dimensions clearly marked)
- Cross-Section Drawing (side view, to scale or with dimensions clearly marked)

**\* Please refer to the individual project guidelines (Page B1) provided by MDE to determine the required information on each plan sheet and the acceptable scales for the appropriate project and plan sheet.**

Please submit seven copies of all drawings on 8 1/2 by 11 inch plain white paper. Drawings should be in black and white for ease of copying. The format must be 8 1/2 by 11 inches.





APPENDIX

ALTERNATIVES SIGNATURES FORM.....A2  
LIMITED POWER OF ATTORNEY.....A3  
CRITICAL AREA BUFFER NOTIFICATIONFORM.....A4  
LIVING SHORELINE WAIVER REQUEST.....A5



**ALTERNATIVE SIGNATURES FORM**  
 (Use When an Applicant is Different From the Riparian Property Owner.  
 Both Applicant and Riparian Property Owner Must Sign this Form)

**12A. STATE CERTIFICATION AND FEDERAL PRIVACY ACT STATEMENT:**

Application is hereby made for a permit or permits to authorize the work described in this application. I hereby designate and authorize the agent named on the Abbreviated Joint Federal / State Application to act on my behalf in the processing of this application and to furnish any information that is requested. I certify that the information on the Abbreviated Joint Federal / State Application and on the attached plans and specifications is true and accurate to the best of my knowledge and belief. I understand that any of the agencies involved in authorizing the proposed works may request information in addition to that set forth herein as may be deemed appropriate in considering this proposal. I grant permission to the agencies responsible for authorization of this work, or their duly authorized representative, to enter the project site for inspection purposes during working hours. I will abide by the conditions of all permit(s) or license(s) if issued and will not begin work without the appropriate authorization. I also certify that the proposed works are consistent with Maryland's Coastal Zone Management Plan.

Authorities: Rivers and Harbors Act, Section 10, 33 USC 403; Clean Water Act, Section 404, 33 USC 1344; Marine Protection, Research, and Sanctuaries Act, Section 103, 33 USC 1413; Regulatory Programs of the Corps of Engineers, 33 CFR 320-332.

Principal Purpose: Information provided on this JPA will be used in evaluating the application for a permit. Routine Uses: This information may be shared with the Department of Justice and other federal, state, and local government agencies, and the public and may be made available as part of a public notice. Submission of requested information is voluntary, however, if information is not provided, the permit application cannot be evaluated nor can a permit be issued.

**An application that is not completed in full will be returned.**

**Applicant(s)**

Applicant's Name (printed/typed)	Applicant's Signature	Date
Applicant's Name (printed/typed)	Applicant's Signature	Date
Applicant's Name (printed/typed)	Applicant's Signature	Date

**Riparian Property Owner(s)**

Riparian Property Owner's Name (printed/typed)	Riparian Property Owner's Signature	Date
Riparian Property Owner's Name (printed/typed)	Riparian Property Owner's Signature	Date
Riparian Property Owner's Name (printed/typed)	Riparian Property Owner's Signature	Date



# LIMITED POWER OF ATTORNEY

<Agent/contractor/applicant's representative can INSERT any LANGUAGE HERE THAT MEETS YOUR NEEDS FOR YOUR COMPANY> \*\*\*along with your name, company name, and contact information\*\*\*

## STATE CERTIFICATION AND FEDERAL PRIVACY ACT STATEMENT:

Application is hereby made for a permit or permits to authorize the work described in this application. I hereby designate and authorize the agent named on the Abbreviated Joint Federal / State Application to act on my behalf in the processing of this application and to furnish any information that is requested. I certify that the information on the Abbreviated Joint Federal / State Application and on the attached plans and specifications is true and accurate to the best of my knowledge and belief. I understand that any of the agencies involved in authorizing the proposed works may request information in addition to that set forth herein as may be deemed appropriate in considering this proposal. I grant permission to the agencies responsible for authorization of this work, or their duly authorized representative, to enter the project site for inspection purposes during working hours. I will abide by the conditions of all permit(s) or license(s) if issued and will not begin work without the appropriate authorization. I also certify that the proposed works are consistent with Maryland's Coastal Zone Management Plan.

Authorities: Rivers and Harbors Act, Section 10, 33 USC 403; Clean Water Act, Section 404, 33 USC 1344; Marine Protection, Research, and Sanctuaries Act, Section 103, 33 USC 1413; Regulatory Programs of the Corps of Engineers, 33 CFR 320-332.

Principal Purpose: Information provided on this JPA will be used in evaluating the application for a permit. Routine Uses: This information may be shared with the Department of Justice and other federal, state, and local government agencies, and the public and may be made available as part of a public notice. Submission of requested information is voluntary, however, if information is not provided, the permit application cannot be evaluated nor can a permit be issued.

**An application that is not completed in full will be returned.**

Owners

Mailing

Address:

\_\_\_\_\_  
Riparian Property Owner's Name

Project Site

Address:

Owner's

Contact

Number:

\_\_\_\_\_  
Riparian Property Owner's E-mail

\_\_\_\_\_  
PROPERTY OWNER MUST SIGN

\_\_\_\_\_  
DATE

<Agent/contractor/applicant's representative can INSERT ANY ADDITIONAL LANGUAGE HERE THAT MEETS YOUR NEEDS FOR YOUR COMPANY>



**CRITICAL AREA BUFFER NOTIFICATION FORM**  
**NOTICE TO SHORE EROSION CONTROL APPLICANTS**

Submittal Requirements

**WHEN submitting a shore erosion control application to the Maryland Department of the Environment (MDE),** the owner or their representative shall include with the application the following:

1. The proposed Buffer Management Plan
2. This Critical Area Buffer Notification Form

Examples of Buffer Management Plans can be obtained by contacting the local government or the Critical Area Commission. This information is also available on the Commission’s website (See contact information at the bottom of this form).

**NOTICE**

1. MDE may determine the application is incomplete if the DRAFT Buffer Management Plan or this form is not included with the application.
2. In addition to a federal or State authorization, a local government approval is required before you begin your project.
3. Before beginning any work, including site preparation and stockpiling of materials, the owner or their representative must obtain:
  - i. An authorization from MDE to construct and install a shore erosion control measure;
  - ii. Approval of the Buffer Management Plan from the local jurisdiction; AND
  - iii. Any other required local permits.
4. Buffer disturbance without a locally approved Buffer Management Plan or buffer disturbance that is not consistent with a locally approved Buffer Management Plan is a violation of State and local laws.

**CERTIFICATION**

I have read and understand the requirements described in this NOTIFICATION FORM. I will abide by these requirements and the conditions of any State authorization and/or local approval. I will not begin any work without all required proper authorizations. Upon reasonable notice, I authorize the right to enter for periodic on-site evaluation by official representatives of the local Critical Area permitting authority.

SIGNATURE OF RIPARIAN PROPERTY OWNER OR REPRESENTATIVE:

\_\_\_\_\_

PRINTED NAME: \_\_\_\_\_

DATE: \_\_\_\_\_

ADDRESS OF SHORE EROSION CONTROL PROJECT (Street #, Street, City, State, Zip code):

\_\_\_\_\_

CRITICAL AREA COMMISSION FOR THE CHESAPEAKE AND ATLANTIC COASTAL BAYS  
1804 West Street, Suite 100 • Annapolis, MD 21401 • 410-260-3460  
See the following website for a list of local Critical Area permitting authorities:  
[www.dnr.maryland.gov/criticalarea/Pages/default.aspx](http://www.dnr.maryland.gov/criticalarea/Pages/default.aspx)





# **Living Shoreline Waiver Request**

## ***Maryland Department of the Environment***

### ***Water and Science Administration***



## **INSTRUCTIONS**

Shore erosion control projects must consist of nonstructural shoreline stabilization measures that preserve the natural environment (i.e. Living Shorelines or marsh creation) unless:

- A waiver is obtained from the Maryland Department of the Environment (MDE); or
- The project shoreline has been mapped by MDE as an area appropriate for structural shoreline stabilization measures (i.e. revetment, groin, bulkhead, etc.). These maps are available on *MDE's website*:

<http://mde.maryland.gov/programs/Water/WetlandsandWaterways/DocumentsandInformation/Pages/wetlandtidalshoremeps.aspx>

In addition to the areas already mapped by MDE, certain sites will not be suitable for nonstructural shoreline stabilization measures due to site-specific characteristics. For example, at sites with excessive erosion, severe high energy conditions, extreme water depths, or a narrow waterway, a living shoreline may not be feasible and a property owner may be eligible for a waiver from the requirement to construct a nonstructural shoreline stabilization measure.

To Determine if your site meets these criteria and is eligible for a waiver:

1. Complete this Waiver Request Form.
2. Mail photographs of the project site along with the completed Waiver Request Form to:

Maryland Department of the Environment  
Tidal Wetlands Division  
1800 Washington Blvd.  
Baltimore, MD 21230

Attention: *(Name of MDE Reviewer if Known)*

3. Complete a **Pre-Application Meeting Request Form** and submit the form by email or by mail with the completed Waiver Request Form and project site photographs to the above address.
4. After receiving all of the required information, MDE will contact the property owner or primary contact, if one is designated, to arrange a site visit. After the site visit, MDE will notify the property owner or primary contact, if one is designated, whether the Living Shoreline Waiver Request was approved.

Please be advised that for **ALL** shore erosion control projects, a property owner must obtain a State tidal Wetlands authorization and all other applicable federal, State, or local authorizations before beginning construction. A completed Living Shoreline Waiver Request Form is not authorization of your proposed project or authorization to begin work.

- a) To obtain a State tidal wetlands authorization to construct a shore erosion control project, a property owner must complete the following documents and submit them to MDE:
- b) A **Joint Federal/State Application for the Alteration of any Tidal Wetland in Maryland**;
- c) A proposed **Critical Area Buffer Management Plan**;
- d) A **Critical Area Buffer Notification Form**; and
- e) If applicable, a **Living Shoreline Waiver** approved by MDE.



## LIVING SHORELINE WAIVER WORKSHEET

Project Site Address:			
City, State, Zip:			
	<b>Existing Structure</b>	Is the proposed project a replacement of a previously authorized, functional structure i.e. replacement bulkhead? <u>If yes, then check the yes box and do not fill out the rest of the form.</u>	<input type="checkbox"/> Yes (Waiver) <input type="checkbox"/> No
	<b>Mapped Shoreline</b>	Is the applicant's proposed project's shoreline mapped by MDE as an area appropriate for structural shoreline stabilization measures? If unknown, leave this section blank. <u>If yes, then check the yes box and do not fill out the rest of the form.</u>	<input type="checkbox"/> Yes (Waiver) <input type="checkbox"/> No
<b>1</b>	<b>Navigation</b>	Distance in feet from the Mean High Water Line to the centerline of the closest mapped or unmapped navigable channel.	
<b>2</b>	<b>Width of Waterway</b>	Distance in feet from Mean High Water Line of proposed project's shoreline perpendicular across the waterway to the Mean High Water Line on the opposite shoreline.	
<b>3</b>	<b>Depth at Toe of Bank</b>	Depth of the water in feet from the Mean Low Water Line to the bottom or toe of the shoreline bank.	
<b>4</b>	<b>Depth of Waterway</b>	Depth of water in feet relative to the Mean Low Water Line at 20-foot and 40-foot channelward of the Mean High Water Line at the proposed project's shoreline.	<u>At 20 ft.</u> <u>At 20 ft.</u>
<b>5</b>	<b>Shoreline Orientation</b>	A. Provide a compass direction perpendicular to the line of the proposed project's shoreline. Direction can be given as NE, SW, etc. or as a compass heading (i.e., 45°, 225°).	
		B. Is Bank grading or tree trimming required to provide at least six hours of daily sunlight.	
<b>6</b>	<b>Fetch</b>	Provide four measurements (in feet) of maximum unobstructed distance over open water for each compass quadrant (i.e., NE, SE, SW, NW) centered on the proposed project's location on the applicant's shoreline.	<u>NW</u> <u>NE</u>
			<u>SW</u> <u>SE</u>
<b>7</b>	<b>Bottom Material</b>	Firmness of bottom material in the proposed project's area of impact.	<input type="checkbox"/> Hard <input type="checkbox"/> Soft
		Type of bottom material in the proposed project's area of impact.	<input type="checkbox"/> Muck <input type="checkbox"/> Silt <input type="checkbox"/> Sand <input type="checkbox"/> Clay
	<b>Sensitive Species</b>	Will project construction adversely impact fish, plant, underwater vegetation, marsh, shellfish, wildlife habitat, or the area within 100 feet landward of the proposed project's shoreline? If unknown, leave this section blank.	<input type="checkbox"/> Yes (provide explanation and attach to this form) <input type="checkbox"/> No
	<b>Site Access</b>	A. Can the proposed project be constructed from the water?	<input type="checkbox"/> Yes <input type="checkbox"/> No
		B. Does the access to the site require any grading or trimming of vegetation?	<input type="checkbox"/> Yes <input type="checkbox"/> No
<p><b>I certify that the information on this form is true and accurate to the best of my knowledge and belief.</b></p> <p>RIPARIAN PROPERTY OWNER SIGNATURE: _____ DATE: _____</p> <p>RIPARIAN PROPERTY OWNER NAME (PRINT): _____</p>			



# MDE LIVING SHORELINE WAIVER REQUEST SAMPLE 1, PLAN VIEW

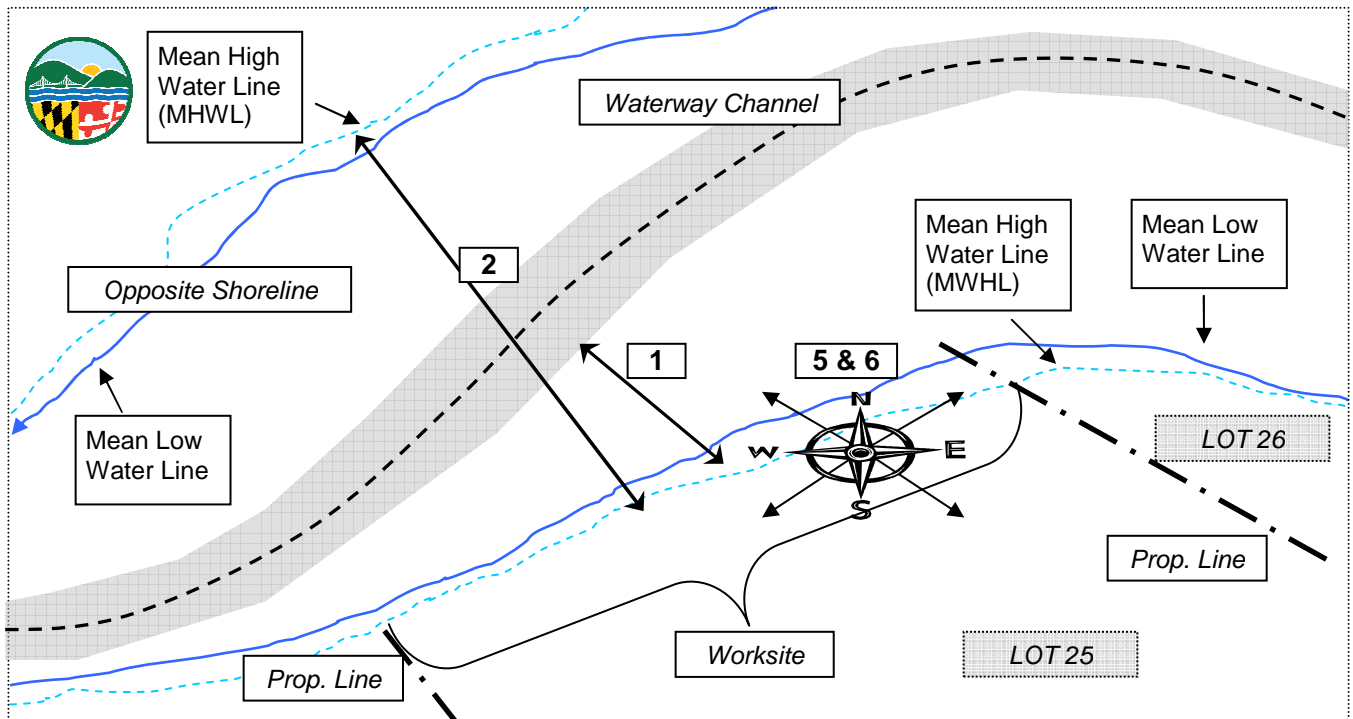



- |  |  |
|--|--|
| <p><b>1</b> <b>Navigation:</b> Distance from the MHWL to edge of Navigation Channel</p> <p><b>2</b> <b>Width of waterway:</b> Distance from the MHWL of the project shoreline perpendicular across the waterway to the MHWL on the opposite shoreline. 0</p> | <p><b>5</b> <b>Shoreline orientation:</b> compass direction perpendicular to average worksite shoreline</p> <p><b>6</b> <b>Fetch:</b> Provide four (4) measurements of maximum fetch for each quadrant (i.e., NE, SE, SW, NW) centered on the worksite shoreline</p> |
|--|--|



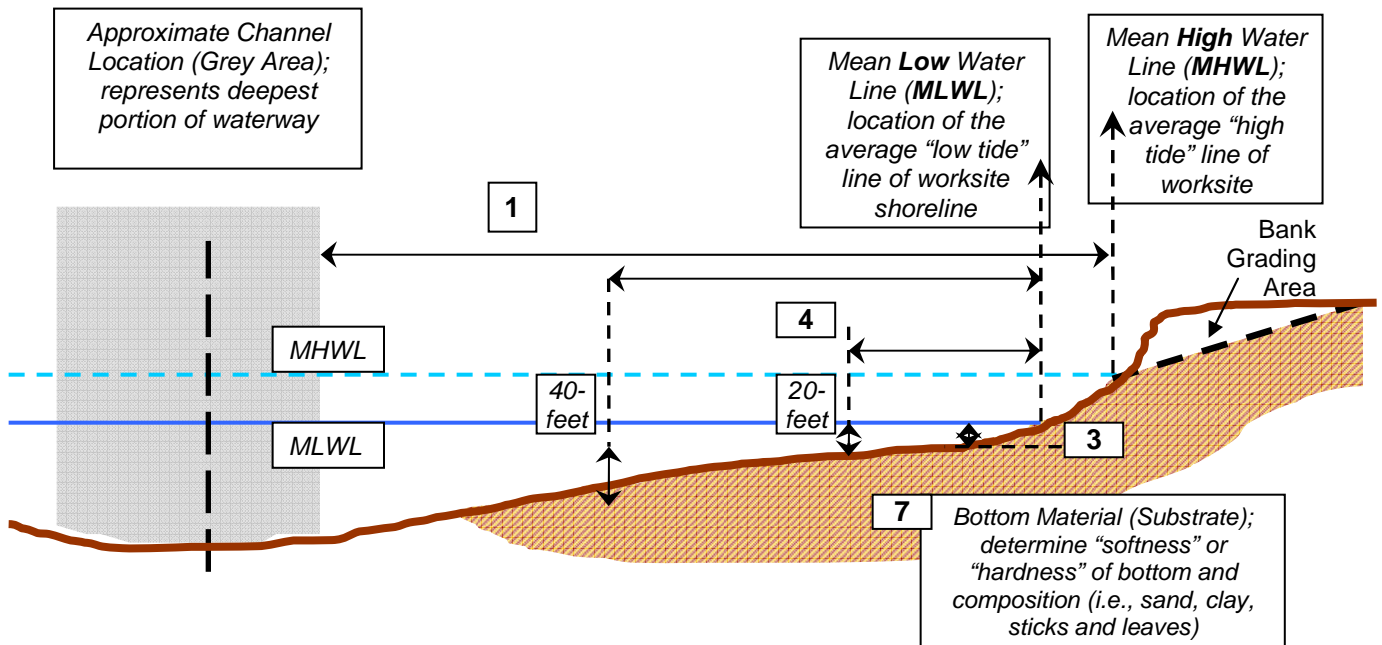

## MDE LIVING SHORELINE WAIVER REQUEST SAMPLE 2 (CROSS SECTION)



<p><b>MHWL</b> Mean High Water Line</p> <p><b>MLWL</b> Mean Low Water Line; referenced to <b>0.0 ft.</b></p> <p><b>1</b> <b>Navigation:</b> Distance from the MHWL to edge of Navigation Channel</p>	<p><b>3</b> Depth of Water at toe or bottom of bank</p> <p><b>4</b> Depth of water during <u>low tide</u> at approximately 20-feet channelward of the MLWL and at approximately 40-feet channelward of the MLWL</p>	
--	---	---

# SAMPLE ACTIVITY GUIDELINES AND DRAWINGS



**Maryland Department of the Environment  
Wetlands and Waterways Program  
Tidal Wetlands Division**

**October 2017**

**Prepared by:**



**Maryland**  
Department of  
the Environment

## PROJECT DRAWINGS

Please submit seven copies of all drawings on 8 1/2 by 11 inch plain white paper. Drawings should be in black and white for ease of copying. The format must be 8 1/2 by 11 inches.

Each drawing should identify the project, the applicant, and the type of illustration (vicinity map, plan view, or cross-section). While illustrations need not be professional (many small, private project illustrations are prepared by hand), they should be clear, accurate, to an appropriate scale (as described in the appropriate proposed activity guidelines and sample plans sheets included at the end of this section), and contain all necessary information. If a scale is not used, all dimensions must be clearly depicted in the drawings. If available, a plat of the property should be included, with the existing and proposed structures clearly indicated. Use heavy dark lines and dot shading, hatching or similar graphic symbols in place of color shading (**use of colored plans are not acceptable for tidal wetland applications**). Distances from the proposed structure(s) to fixed points of reference (benchmarks) and to adjacent property lines must be shown.

At a minimum, the following items must be included on ALL project drawings (plan and section, as appropriate):

- North arrow
- Waterway name
- Existing and proposed structures, labeled as such
- Dimensions of all proposed structures
- Dimensions of all existing structures
- Defined dredge area showing the dimensions of the proposed area and the amount of resultant dredged material in cubic yards
- Existing and proposed water depths, measured at mean low water in the project area and channelward of the project area. Water depths can be marked as either contours or spot depths that extend across the width of the waterway.
- Identify the name and location of the proposed dredged material placement (DMP) site and the method of disposing of, including transportation of, the dredged material.
- Mean high water and mean low water lines. (If the mean high water and mean low water lines are to be altered during construction, the proposed MHWL and MLWL should also be labeled)
- Distance the proposed structures extend from the MHWL into the waterway
- Limits of vegetated wetlands, if applicable
- Limits of submerged aquatic vegetation, if applicable
- Ebb/flood direction
- Adjacent property lines and adjacent property owner's name(s)
- Distance of the proposed work to the adjacent property lines
- Distances from proposed structures to fixed points of reference (benchmarks)

Sample activity guidelines and drawings have been included at the end of this Section to provide guidance on the information needed to consider your application complete and allow for timely processing. Clear and accurate drawings are essential for project review and compliance determination. The proposed drawings and/or plans should focus on the proposed project's tidal portion of the property and the immediate upland area of the site. Incomplete or unclear drawings may cause delays in the processing of your application.

Recent photographs of the proposed project area are appreciated, but not required.



# SAMPLE ACTIVITY GUIDELINES AND DRAWINGS

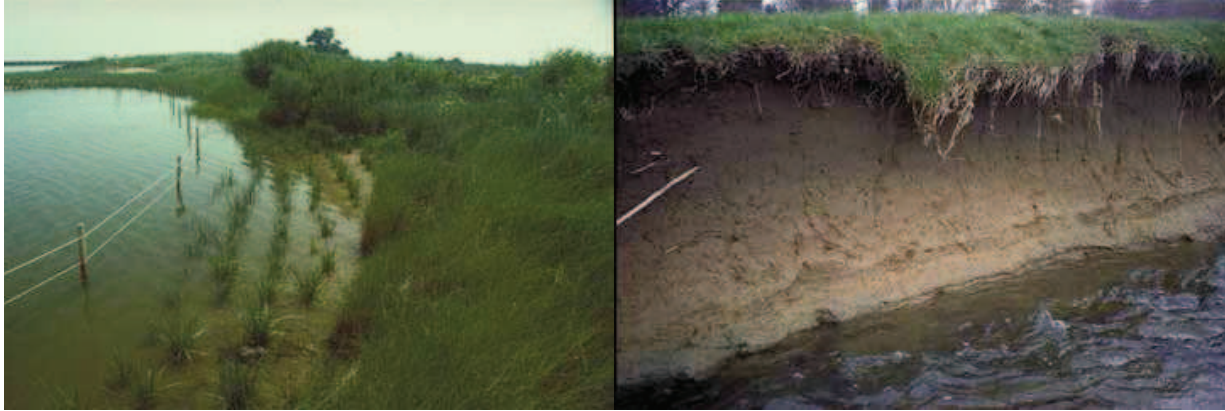

**Maryland Department of the Environment  
Wetlands and Waterways Program  
Tidal Wetlands Division**

**August 2013**

**Prepared by:**



**Maryland**  
Department of  
the Environment

**THIS PAGE INTENTIONALLY LEFT BLANK**

**WETLANDS AND WATERWAYS PROGRAM  
TIDAL WETLAND APPLICATION GUIDELINES**

**PROPOSED BOAT LIFT / MOORING PILES / PLATFORM PROJECT**

Check list outlines the minimum required information for a proposed project; additional information may be required based on the project and/or the applicant's project site. Applicants are encouraged to schedule a pre-application meeting to answer questions, discuss the applicant's site, discuss the proposed project, and determine if any additional information/plan sheets are required due to the uniqueness of the applicant's site.

- Requires application processing fee\* (Boat lift with new pilings / new mooring piles / platform)
- Exempt from application processing fee\* (Boat lift on existing pilings)

**\*Reference the fee guidelines and tables to determine appropriate application review fees.**

**APPLICATION GUIDELINES**

- 
- ABBREVIATED JOINT FEDERAL / STATE APPLICATION FOR THE ALTERATION OF ANY TIDAL WETLAND AND/OR TIDAL WATERS IN MARYLAND
- 
- Contiguous Property Owner and Appropriate Local Official Notification and Certification Form
- 
- Photographs of project site and any existing structures.
- 

**GENERAL PLAN REQUIREMENTS**

- 
- Plan sheets should be on 8.5" x 11" paper, black and white, and single sided; Plans are to be legible and not cluttered; usable written or visual scale no smaller than 1" = 50' on proposed plan sheets and a usable written or visual scale no smaller than 1" = 100' on existing plan sheets. All plan notes should be placed at the bottom of the page or on a separate page. The plan sheets should be numbered to reference the plan sheet in relation to the total number of plan sheets i.e. Page 1 of 3, Page 2 of 3, etc.
- 

**VICINITY MAP & AERIAL PHOTO PLAN SHEET**

- 
- Plan sheets should be on 8.5" x 11" paper, black and white, and single sided; All plan notes should be placed at the bottom of the page or on a separate page. The plan sheets should be numbered to reference the plan sheet in relation to the total number of plan sheets i.e. Page 1 of 3, Page 2 of 3, etc.
- 
- Plan sheet should include the type of projects proposed by applicant i.e. boat lift, mooring piles, or platform.
- 
- Plan sheet should include the name of the applicant(s) and mailing address including the town/city, county, state, and zip code.
- 
- Vicinity map and aerial photo should be sized to clearly depict the project site and surrounding area, but each map should no smaller than 4" by 4" in size.
- 
- Vicinity map should include a North arrow and be scaled to clearly show project site, general location on the waterway, the immediate surrounding area.
- 
- Aerial photograph should be no more than 10 years old from date of application.
-

---

VICINITY MAP & AERIAL PHOTO PLAN SHEET (CONTINUED)

---

- Aerial photograph should, at a minimum, show the proposed project site (clearly marked) with any existing structures and the adjacent property owners' property with any existing structures.
- 

EXISTING AND PROPOSED CONDITION PLAN SHEETS

---

- Plan sheets should be on 8.5" x 11" paper, black and white, and single sided; Plans are to be legible and not cluttered; usable written or visual scale no smaller than 1" = 50' on existing plan sheets. All plan notes should be placed at the bottom of the page or on a separate page. The plan sheets should be numbered to reference the plan sheet in relation to the total number of plan sheets i.e. Page 1 of 3, Page 2 of 3, etc.
- 
- Plan sheet should include the type of projects proposed by applicant i.e. boat lift, mooring piles, or platform.
- 
- Plan sheet should include the name of the applicant(s) and mailing address including the town/city, county, state, and zip code.
- 
- Plan view should include the Mean High Water Line (MHWL) and the Mean Low Water Line (MLWL; referenced to 0.0 feet).
- 
- Plan view should include water depths marked as either contours or spot depths that extend to the channelward end of the pier or proposed boat lift (whichever is greater).
- 
- Plan view should include the name of the waterway, North arrow, and direction of ebb/flow tide.
- 
- Plan view should include the shoreline from property line to property line.
- 
- Plan view should include the property lines extended channelward and labeled
- 
- Plan view should include the construction restriction set back lines extended channelward and labeled or if distance from the proposed project to the construction restriction set back lines will not fit on the page using the allowable scale the distance to each construction restriction set back line from the proposed project should be indicated.  
**\*Check with the county to determine the appropriate required set back distance for tidal wetland projects. In counties where no county set back is required, MDE requires a minimum of 10 feet or a variance from the county prior to issuance of a State license.**
- 
- Plan view should include the applicant's property and directly adjacent riparian properties clearly labeled with their name, site address, town/city, county, state, and zip code.
- 
- Plan view should include all existing structures, including vegetated wetlands and SAV, on the applicant's property and adjacent riparian properties.
- 
- Plan view should depict the location of the proposed boat lift and the existing or proposed associated pilings with the pilings clearly labeled as existing or proposed.
- 
- Plan view should depict proposed boat lift or PWC locations with an X connecting the boat lift piles. **\*Please provide, as a separate plan sheet, a schematic, plan, or typical photograph showing the type of boat lift or PWC lift that is proposed.**
- 
- Plan view should depict the location of the proposed mooring piles clearly labeled as proposed.
- 
- Plan view should depict the location of the proposed platform clearly labeled as proposed and the type i.e. fixed or floating.
-



## TYPICAL BOAT LIFT PLAN SHEET

---

- Plan sheets should be on 8.5" x 11" paper, black and white, and single sided; Plans are to be legible and not cluttered. All plan notes should be placed at the bottom of the page or on a separate page. The plan sheets should be numbered to reference the plan sheet in relation to the total number of plan sheets i.e. Page 1 of 3, Page 2 of 3, etc.
  - Plan sheet should include the type of projects proposed by applicant i.e. boat lift, mooring piles, or platform.
  - Plan sheet should include the name of the applicant(s) and mailing address including the town/city, county, state, and zip code.
  - Plan sheet should depict a schematic, photograph, or plan of the type of boat lift proposed to be constructed at applicant's pier.
- 

## CROSS-SECTION PLATFORM PLAN SHEET

---

- Plan sheets should be on 8.5" x 11" paper, black and white, and single sided; Plans are to be legible and not cluttered. All plan notes should be placed at the bottom of the page or on a separate page. The plan sheets should be numbered to reference the plan sheet in relation to the total number of plan sheets i.e. Page 1 of 3, Page 2 of 3, etc.
  - Plan sheet should include the type of projects proposed by applicant i.e. platform.
  - Plan sheet should include the name of the applicant(s) and mailing address including the town/city, county, state, and zip code.
  - Cross-Section views should include the Mean High Water (MHW), the Mean Low Water (MLW; referenced to 0.0 feet). Example: MLW = 0.0', MHW = + 1.9'
  - FIXED PLATFORM** – Proposed Cross-Section should depict the distance from the MLW to the bottom of the platform decking (minimum of 4 feet).
  - FLOATING PLATFORM** – Proposed Cross-Section should depict the distance from the bottom of the floatation structures to the bottom substrate. Typically floating platforms require a minimum of 2 feet of water depth in the proposed location to receive authorization.
-

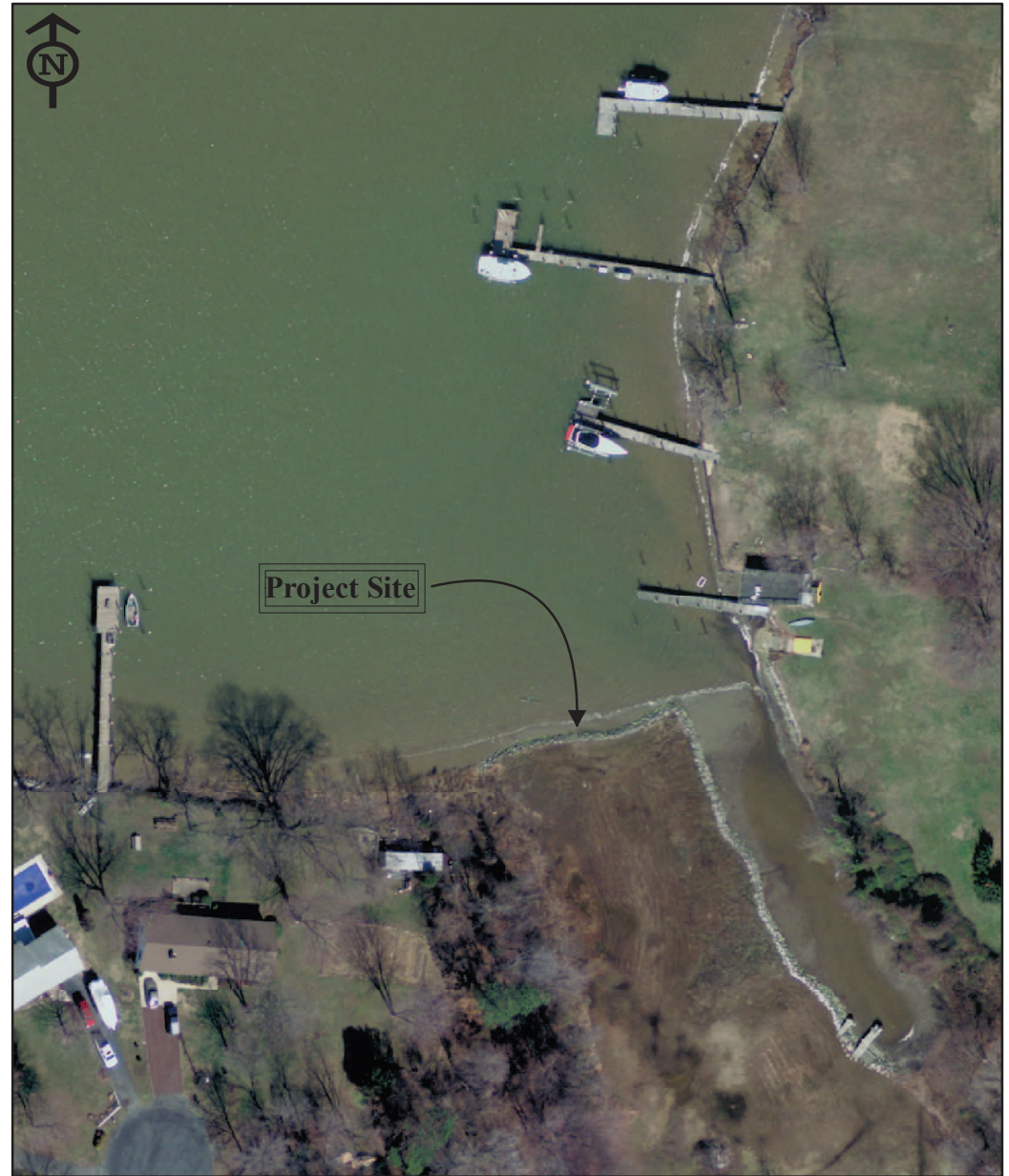
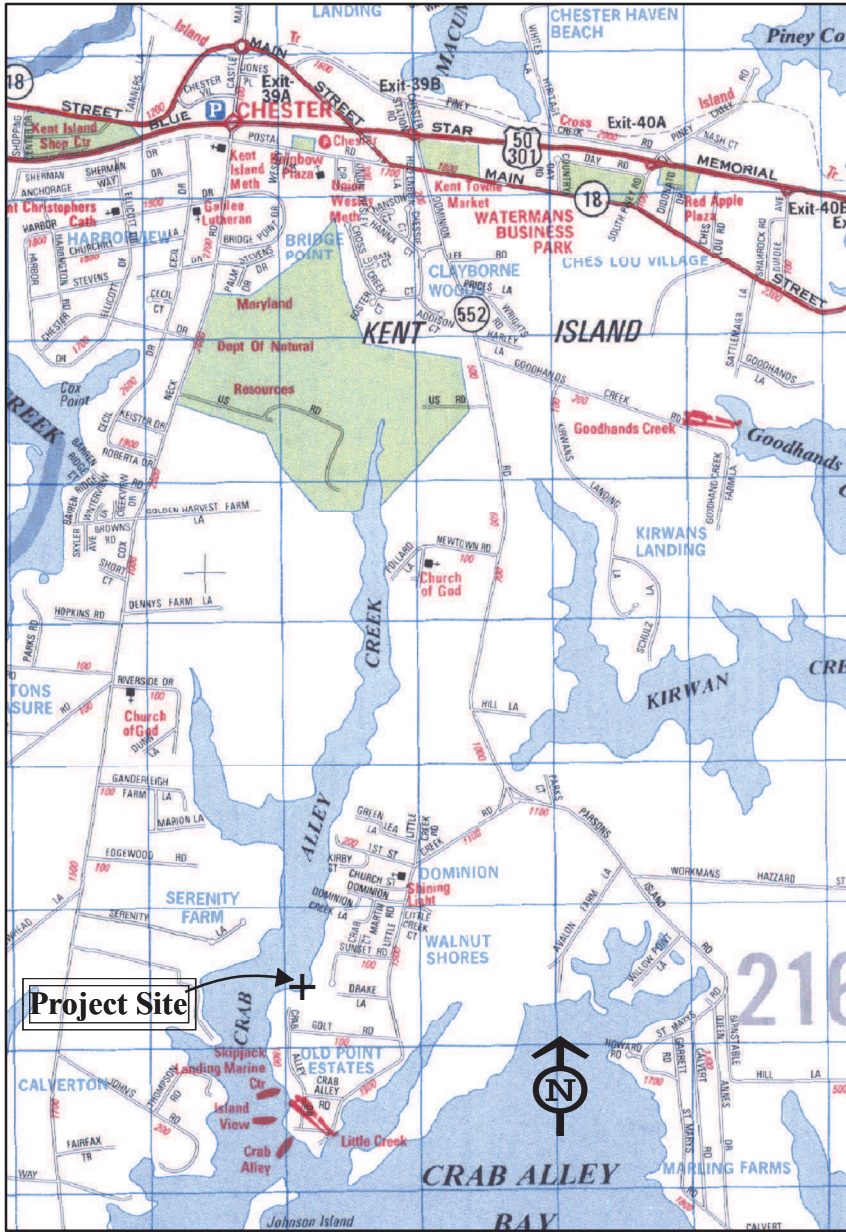

**Vicinity Map & Aerial Photo**

Project: [INSERT TYPE OF PROJECT]

Proposed Project for:  
 Applicant NAME  
 Mailing Address, Town, County, State, Zip Code

NOTES

DATE, Page X of Y

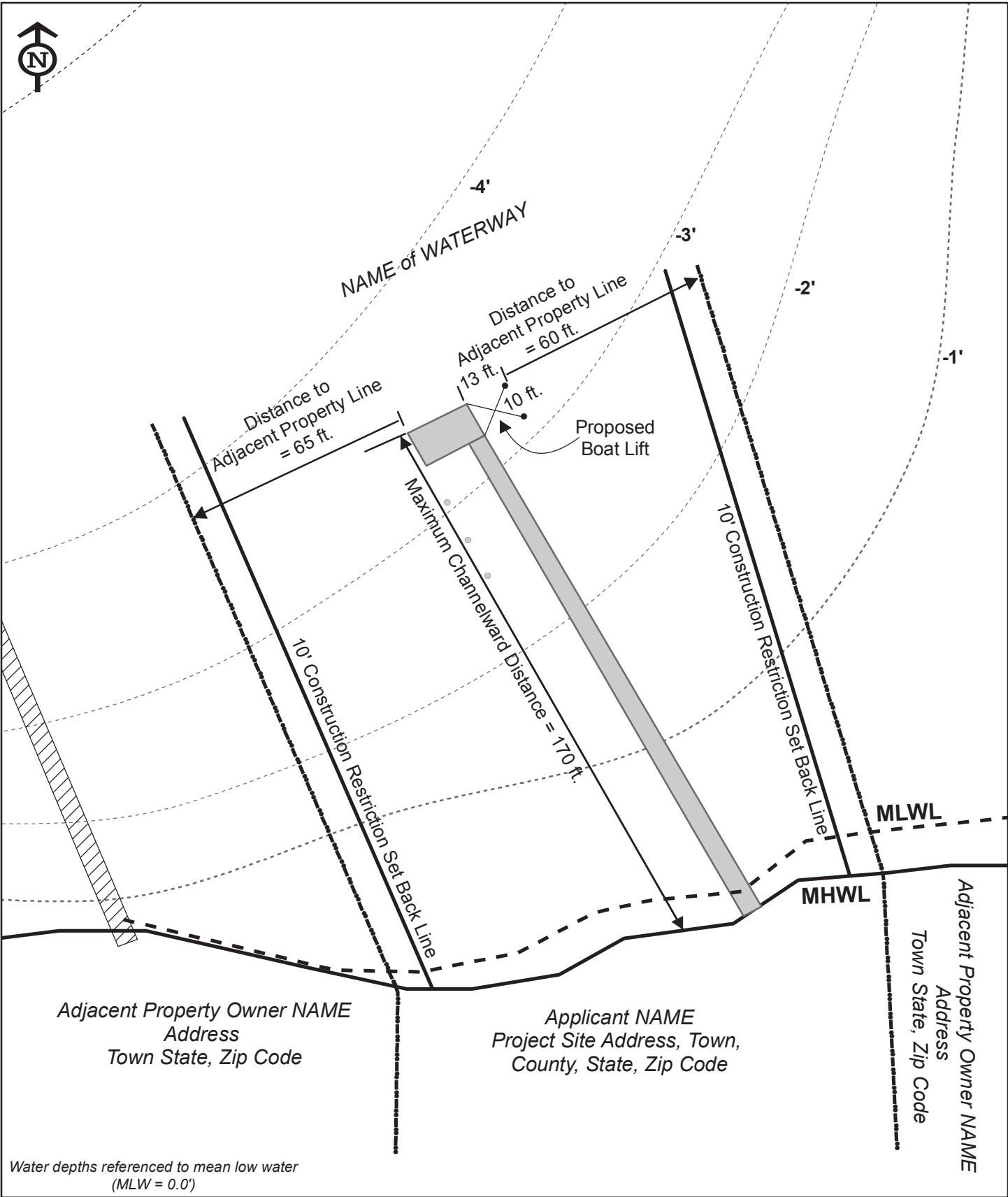

### Existing Conditions with Proposed Boatlift

Project: Proposed Boatlift on existing pier & pilings

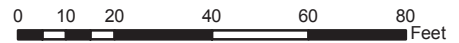

1 inch = 40 feet

Proposed Project for:  
Applicant NAME  
Mailing Address, Town, County, State, Zip Code

- Existing Structure
- Proposed Structure

DATE, Page X of Y



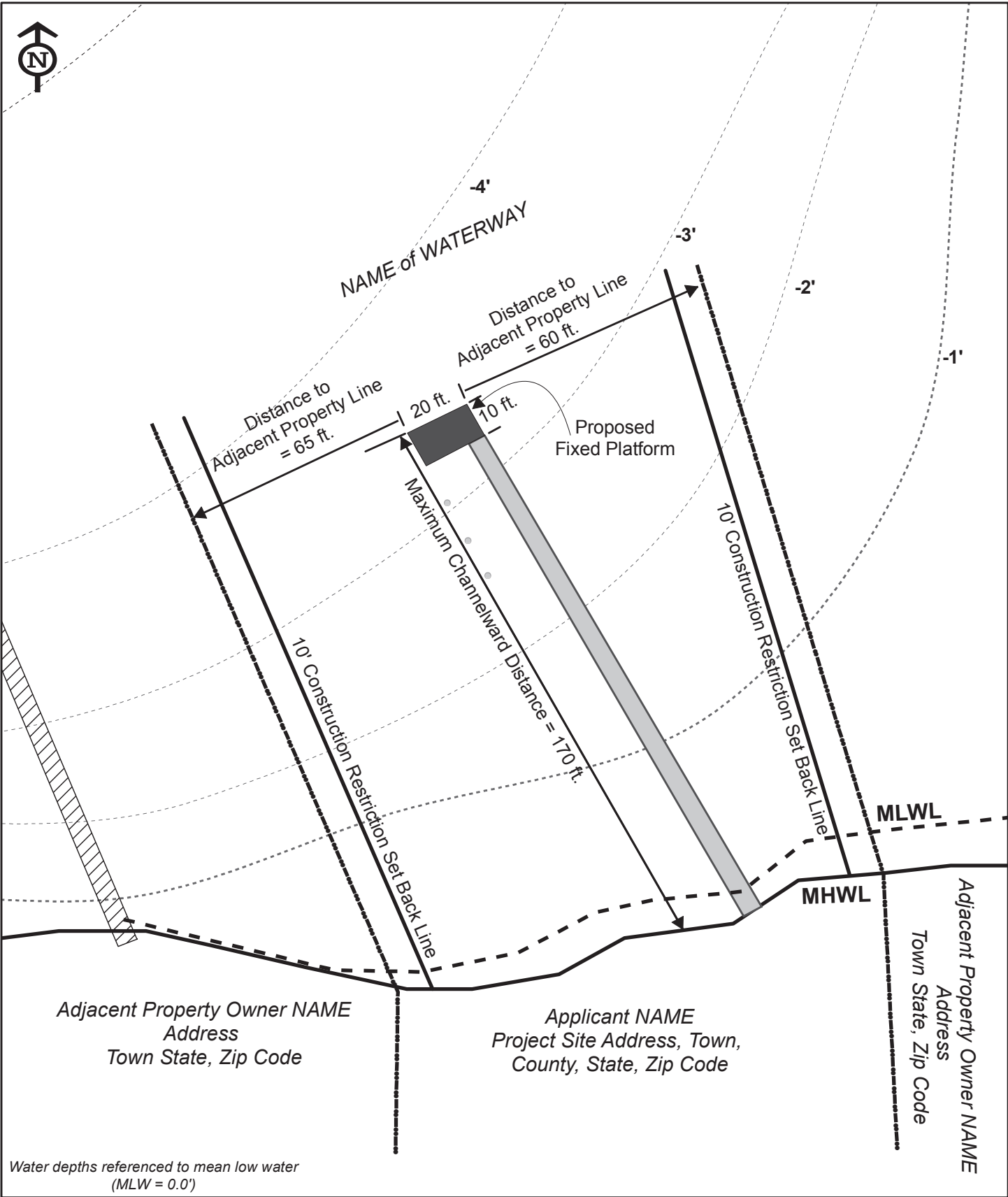

**Existing Conditions with Proposed Platform**

Project: Proposed Platform on an existing pier



1 inch = 40 feet

Proposed Project for:  
Applicant NAME  
Mailing Address, Town, County, State, Zip Code

Existing Structure  
 Proposed Structure

DATE, Page X of Y

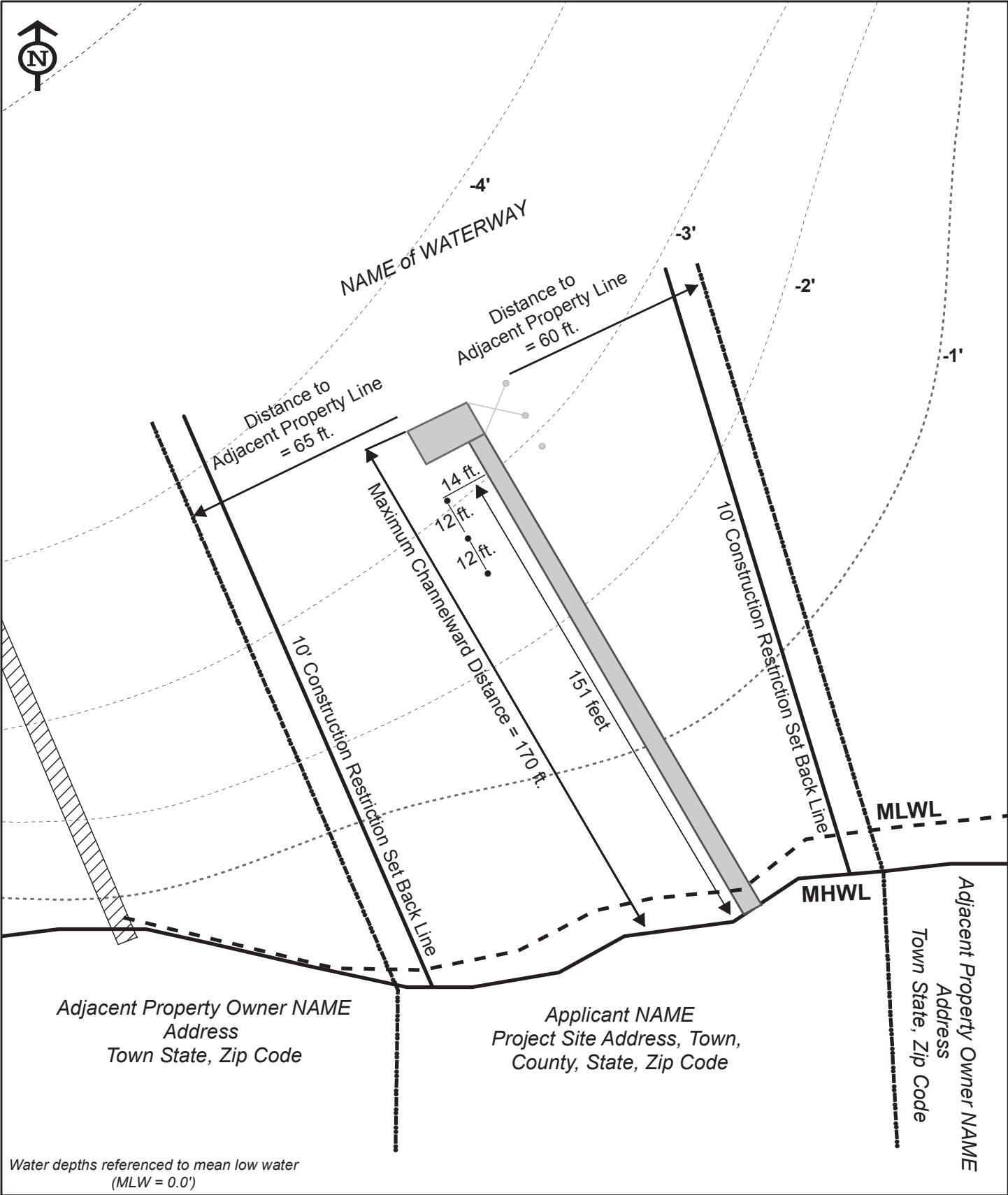

**Existing Conditions with Proposed Mooring Piles**

Project: Proposed mooring piles on an existing pier

Proposed Project for:  
 Applicant NAME  
 Mailing Address, Town, County, State, Zip Code



1 inch = 40 feet

- Existing Structure
- Proposed Structure

DATE, Page X of Y

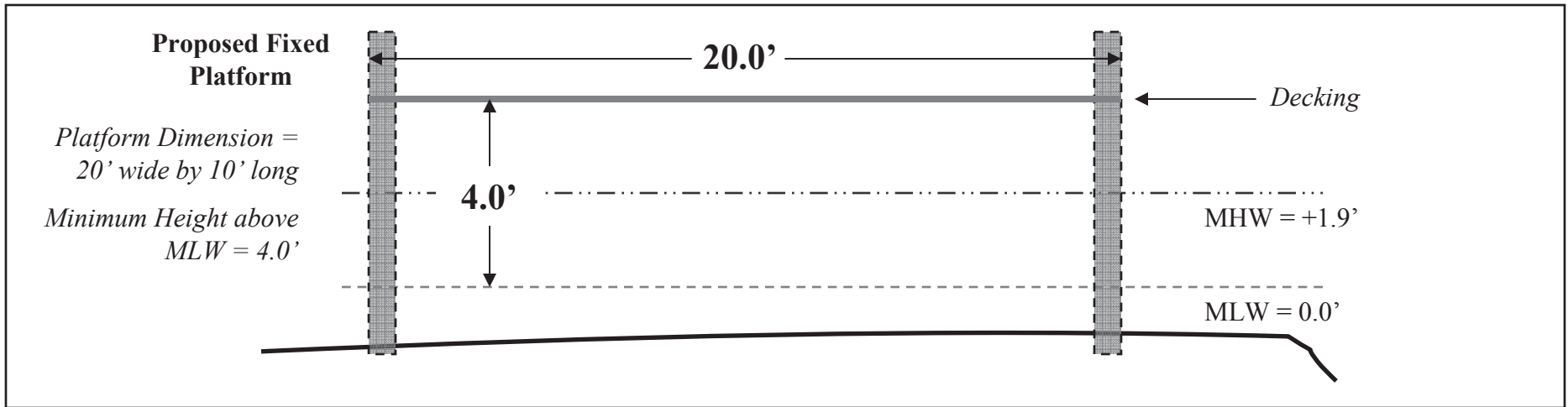
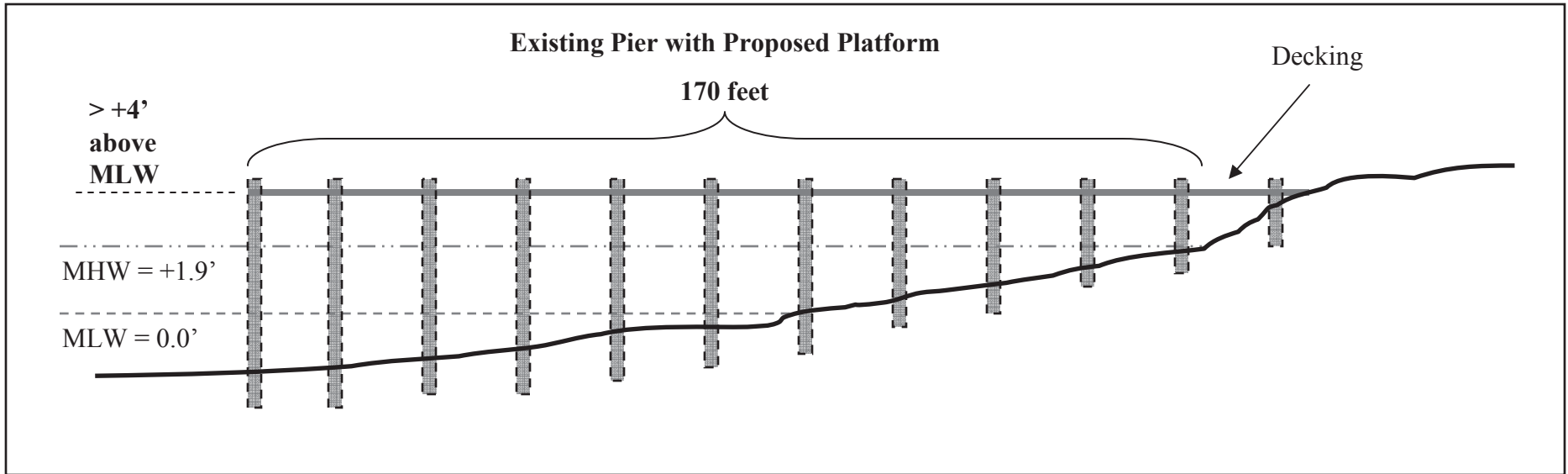

### Platform on Existing Pier Project

Proposed Project Cross-section for:  
 Applicant Name  
 Mailing Address, Town, County, State

**WETLANDS AND WATERWAYS PROGRAM  
TIDAL WETLAND APPLICATION GUIDELINES**

**PROPOSED PIER PROJECT**

Check list outlines the minimum required information for a proposed project; additional information may required based on the project and/or the applicant's project site. Applicants are encouraged to schedule a pre-application meeting to answer questions, discuss the applicant's site, discuss the proposed project, and determine if any additional information/plan sheets are required due to the uniqueness of the applicant's site.

- Requires application processing fee
- Exempt from application processing fee

**\*Reference the fee guidelines and tables to determine appropriate application review fees.**

**GENERAL PLAN REQUIREMENTS**

---

- Plan sheets should be on 8.5" x 11" paper, black and white, and single sided; Plans are to be legible and not cluttered; usable written or visual scale no smaller than 1" = 50' on proposed plan sheets and a usable written or visual scale no smaller than 1" = 100' on existing plan sheets. All plan notes should be placed at the bottom of the page or on a separate page. The plan sheets should be numbered to reference the plan sheet in relation to the total number of plan sheets i.e. Page 1 of 3, Page 2 of 3, etc.
- 

**VICINITY MAP & AERIAL PHOTO PLAN SHEET**

---

- Plan sheets should be on 8.5" x 11" paper, black and white, and single sided; All plan notes should be placed at the bottom of the page or on a separate page. The plan sheets should be numbered to reference the plan sheet in relation to the total number of plan sheets i.e. Page 1 of 3, Page 2 of 3, etc.
  - Plan sheet should include the type of projects proposed by applicant i.e. pier, platform, mooring piles, and boat lift.
  - Plan sheet should include the name of the applicant(s) and mailing address including the town/city, county, state, and zip code.
  - Vicinity map and aerial photo should be sized to clearly depict the project site and surround area, but each map should no smaller than 4" by 4" in size.
  - Vicinity map should include a North arrow and be scaled to clearly show project site, general location on the waterway, the immediate surrounding area.
  - Aerial photograph should be no more than 10 years old from date of application.
  - Aerial photograph should, at a minimum, show the proposed project site (clearly marked) with any existing structures and the adjacent property owners' property with any existing structures.
-



## PROJECT VICINITY CONDITIONS PLAN SHEET(S)

- 
- Plan sheets should be on 8.5" x 11" paper, black and white, and single sided; Plans are to be legible and not cluttered; usable written or visual scaled appropriate for area of project vs. 8.5" x 11" sheet. All plan notes should be placed at the bottom of the page or on a separate page. The plan sheets should be numbered to reference the plan sheet in relation to the total number of plan sheets i.e. Page 1 of 3, Page 2 of 3, etc.
- 
- Plan sheet should include the type of projects proposed by applicant i.e. pier, platform, mooring piles, and boat lift.
- 
- Plan sheet should include the name of the applicant(s) and mailing address including the town/city, county, state, and zip code.
- 
- Plan view should include the Mean High Water Line (MHWL) of project's shoreline and the distance to the opposite shoreline.
- 
- Plan view should include the name of the waterway, North arrow, and direction of ebb/flow tide.
- 
- Plan view should include water depths marked as either contours or spot depths that extend across the width of the waterway.
- 
- Plan view should include any marked or unmarked channels within the waterway and distance to the nearest edge of the channel.
- 
- Plan view should include the property lines (labeled) extended channelward.
- 
- Plan view should include all vegetated wetlands at the applicant's site.
- 

## EXISTING CONDITION PLAN SHEET(S)

- 
- Plan sheets should be on 8.5" x 11" paper, black and white, and single sided; Plans are to be legible and not cluttered; usable written or visual scale no smaller than 1" = 100' on existing plan sheets. All plan notes should be placed at the bottom of the page or on a separate page. The plan sheets should be numbered to reference the plan sheet in relation to the total number of plan sheets i.e. Page 1 of 3, Page 2 of 3, etc.
- 
- Plan sheet should include the type of projects proposed by applicant i.e. pier, platform, mooring piles, and boat lift.
- 
- Plan sheet should include the name of the applicant(s) and mailing address including the town/city, county, state, and zip code.
- 
- Plan view should include the Mean High Water Line (MHWL) and the Mean Low Water Line (MLWL; referenced to 0.0 feet).
- 
- Plan view should include water depths marked as either contours or spot depths that extend a minimum of 100' channelward from the end of the channelward most proposed work.  
**\*Narrow width waterways require water depths across the entire width of the channel.**
- 
- Plan view should include the name of the waterway, North arrow, and direction of ebb/flow tide.
-

## EXISTING CONDITION PLAN SHEET(S) (CONTINUED)

---

- Plan view should include the shoreline from property line to property line (property lines extended channelward and labeled) or if distance from the proposed project to property lines will not fit on the page using the allowable scale the distance to each property line from the proposed project should be indicated.
  - Plan view should include the applicant's property and directly adjacent riparian properties clearly labeled with their name, site address, town/city, county, state, and zip code.
  - Plan view should include all existing structures, including vegetated wetlands and SAV, on the applicant's property and adjacent riparian properties.
- 

## PROPOSED CONDITION PLAN SHEET(S)

---

- Plan sheets should be on 8.5" x 11" paper, black and white, and single sided; Plans are to be legible and not cluttered; usable written or visual scale no smaller than 1" = 50' on proposed plan sheets. All plan notes should be placed at the bottom of the page or on a separate page. The plan sheets should be numbered to reference the plan sheet in relation to the total number of plan sheets i.e. Page 1 of 3, Page 2 of 3, etc.
  - Plan sheet should include the type of projects proposed by applicant i.e. pier, platform, mooring piles, and boat lift.
  - Plan sheet should include the name of the applicant(s) and mailing address including the town/city, county, state, and zip code.
  - Plan view should include the Mean High Water Line (MHWL) and the Mean Low Water Line (MLWL; referenced to 0.0 feet). *If the MHWL or the MLWL are to be altered during construction the proposed MHWL and MLWL should also be labeled.*
  - Plan view should include water depths marked as either contours or spot depths that extend a minimum to the channelward extent of the proposed project.
  - Plan view should include the name of the waterway, North arrow, and direction of ebb/flow tide.
  - Plan view should include the property lines (labeled) extended channelward.
  - Plan view should include the construction restriction set back lines extended channelward and labeled or if distance from the proposed project to the construction restriction set back lines will not fit on the page using the allowable scale the distance to each construction restriction set back line from the proposed project should be indicated.  
**\*Check with the county to determine the appropriate required set back distance for tidal wetland projects. In counties where no county set back is required, MDE requires a minimum of 10 feet or a variance from the county prior to issuance of a State license.**
  - Plan view should depict the proposed pier and all proposed associated structures including the channelward distance from the MHWL to each structure.
  - Plan view should depict proposed boat lift or PWC locations with an X connecting the boat lift piles. **\*Please provide, as a separate plan sheet, a schematic, plan, or typical photograph showing the type of boat lift or PWC lift that is proposed.**
-

### CROSS-SECTION PLAN SHEET(S)

---

- Plan sheets should be on 8.5" x 11" paper, black and white, and single sided; Plans are to be legible and not cluttered. All plan notes should be placed at the bottom of the page or on a separate page. The plan sheets should be numbered to reference the plan sheet in relation to the total number of plan sheets i.e. Page 1 of 3, Page 2 of 3, etc.

---

  - Plan sheet should include the type of projects proposed by applicant i.e. pier, platform, mooring piles, and boat lift.

---

  - Plan sheet should include the name of the applicant(s) and mailing address including the town/city, county, state, and zip code.

---

  - Cross-Section views should include the Mean High Water (MHW), the Mean Low Water (MLW; referenced to 0.0 feet). Example: MLW = 0.0', MHW = + 1.9'

---

  - Existing Cross-Section should depict width of pier decking (maximum 6.0 feet over open water tidal wetlands and a maximum of 3.0 feet over vegetated tidal wetlands).

---

  - Proposed Cross-Section should depict the distance from the MLW to the bottom of the pier decking (minimum of 4 feet over open water tidal wetlands) or the distance from the substrate to the bottom of the pier decking (minimum of 3 feet over vegetated tidal wetlands).
- 

### TYPICAL BOAT LIFT PLAN SHEET(S)

---

- Plan sheets should be on 8.5" x 11" paper, black and white, and single sided; Plans are to be legible and not cluttered. All plan notes should be placed at the bottom of the page or on a separate page. The plan sheets should be numbered to reference the plan sheet in relation to the total number of plan sheets i.e. Page 1 of 3, Page 2 of 3, etc.

---

  - Plan sheet should include the type of projects proposed by applicant i.e. pier, platform, mooring piles, and boat lift.

---

  - Plan sheet should include the name of the applicant(s) and mailing address including the town/city, county, state, and zip code.

---

  - Plan sheet should depict a schematic, photograph, or plan of the type of boat lift proposed to be constructed at applicant's pier.
-



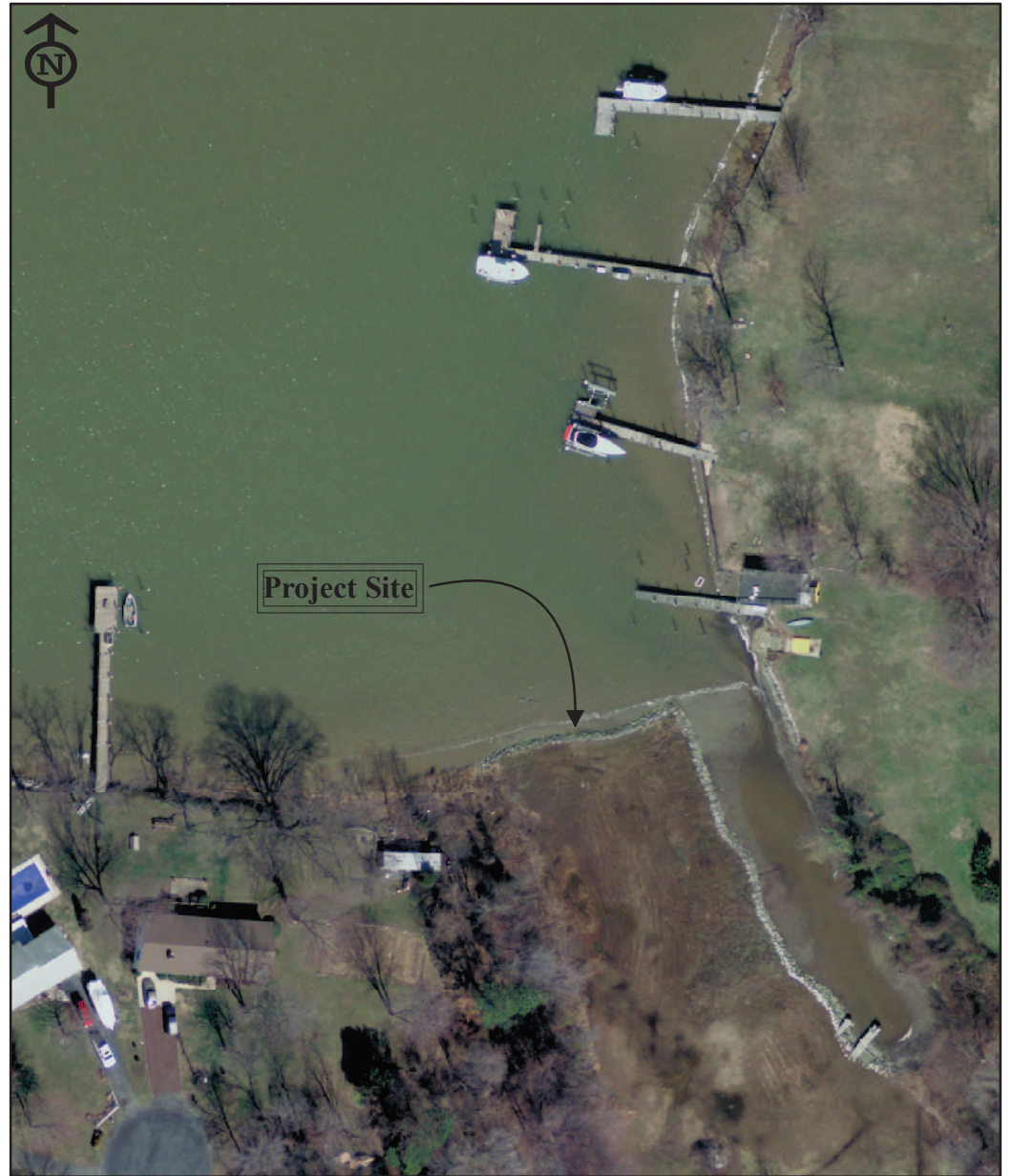
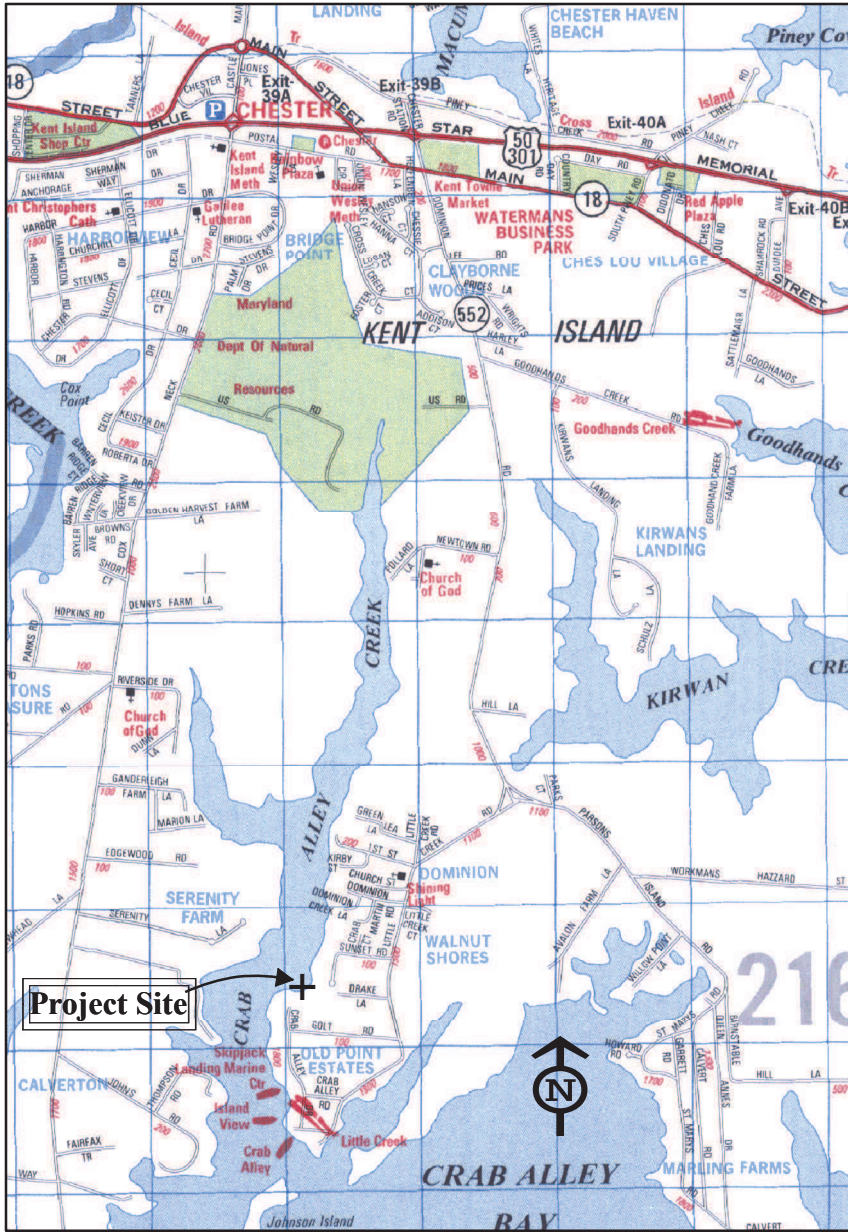

**Vicinity Map & Aerial Photo**

Project: [INSERT TYPE OF PROJECT]

Proposed Project for:  
 Applicant NAME  
 Mailing Address, Town, County, State, Zip Code

NOTES

DATE, Page X of Y

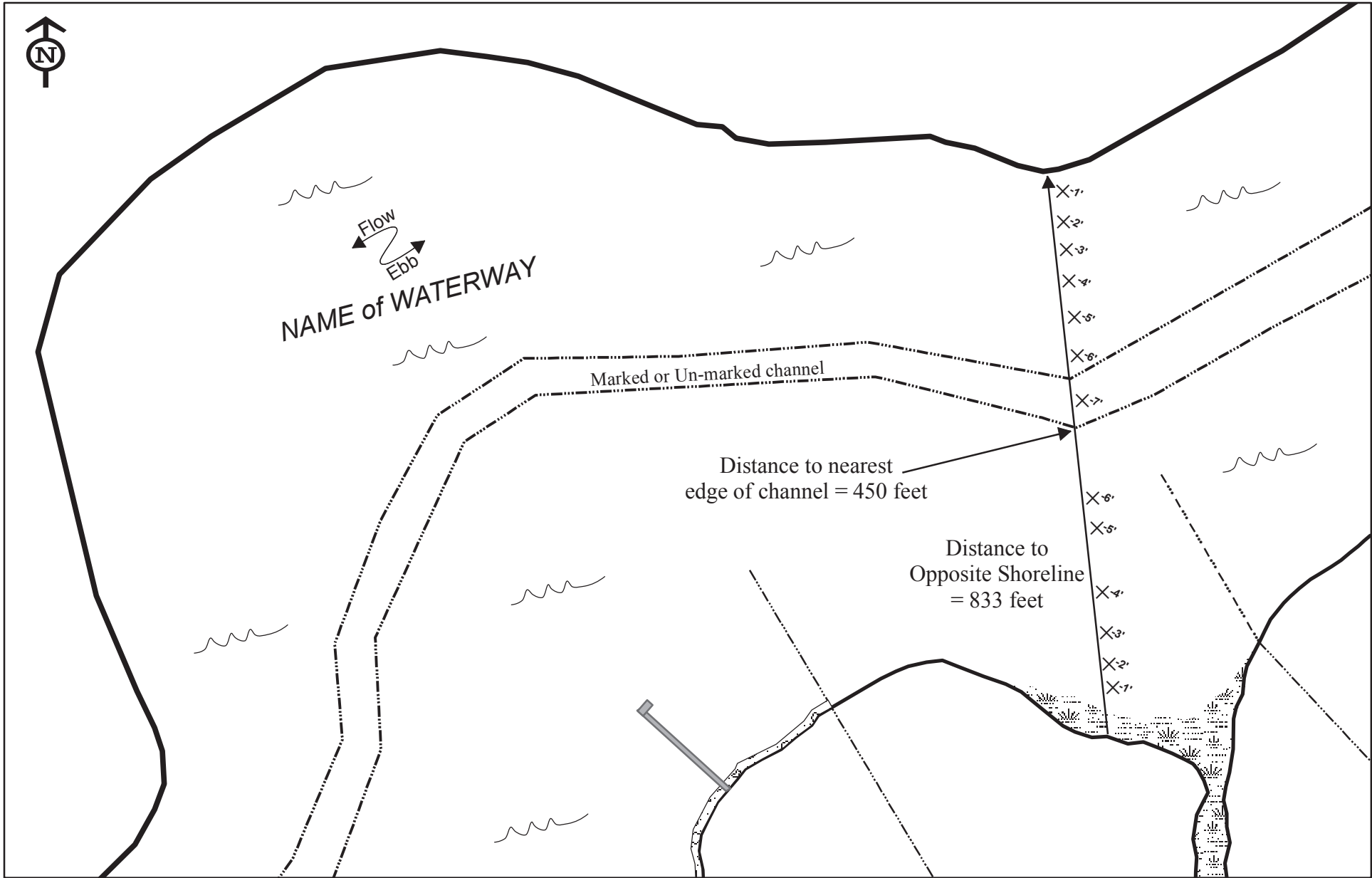

**Project Vicinity Conditions**

Project: Pier, Platform, Pilings, & Boatlift



1 inch = 200 feet

*PROJECT NOTES:*

Proposed Project for:  
Applicant NAME  
Mailing Address, Town, County, State, Zip Code

DATE, Page X of Y

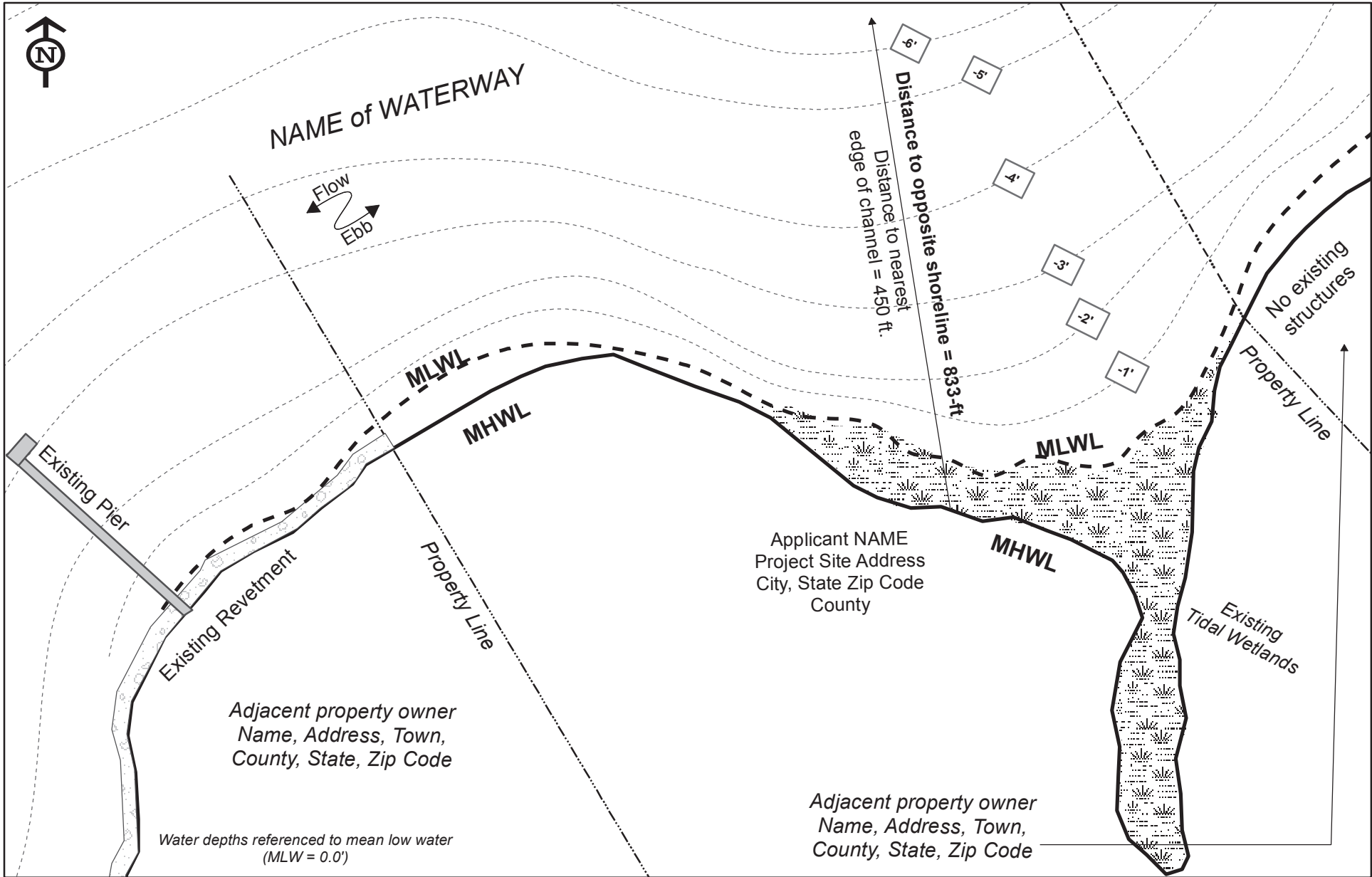

**Existing Conditions**

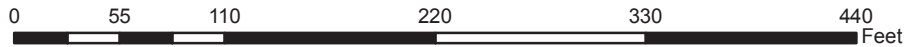

Project: Pier, Platform, Pilings, & Boatlift



1 inch = 100 feet

**PROJECT NOTES:**

Proposed Project for:  
Applicant NAME  
Mailing Address, Town, County, State, Zip Code

-  Existing Structure
-  Proposed Structure

DATE, Page X of Y



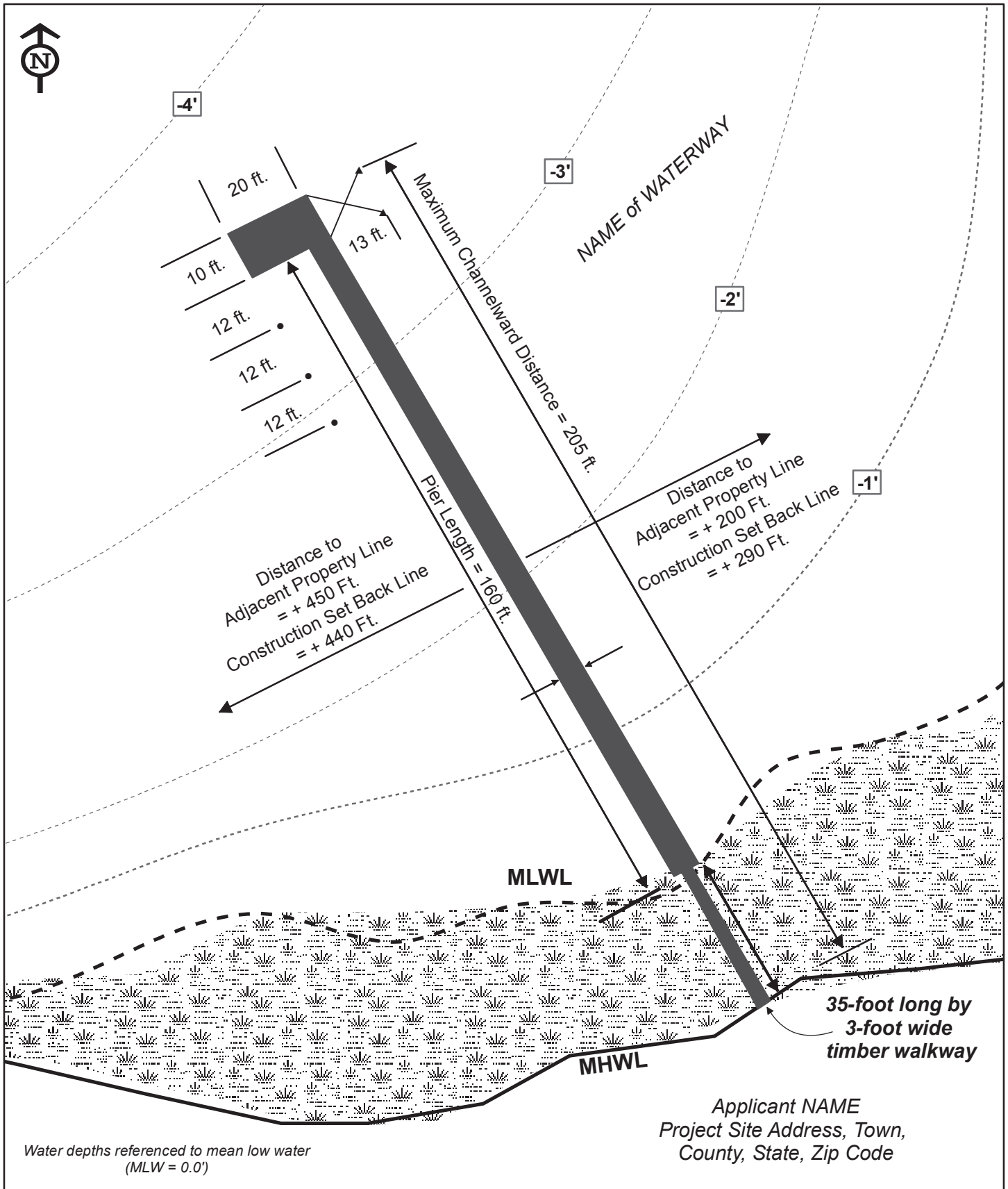

<b>Proposed Conditions</b>	<p>0    12.5    25    50    75    100 Feet</p>	<b>PROJECT NOTES:</b>				
Project: Pier, Platform, Pilings, & Boatlift	1 inch = 30 feet					
Proposed Project for: Applicant NAME Mailing Address, Town, County, State, Zip Code	<table border="1" style="border-collapse: collapse; width: 100%;"> <tr> <td style="text-align: center;">● Mooring Piling</td> <td style="text-align: center;">○ Existing Structure</td> </tr> <tr> <td style="text-align: center;">▲ Boatlift Piling</td> <td style="text-align: center;">● Proposed Structure</td> </tr> </table>	● Mooring Piling	○ Existing Structure	▲ Boatlift Piling	● Proposed Structure	DATE, Page X of Y
● Mooring Piling	○ Existing Structure					
▲ Boatlift Piling	● Proposed Structure					



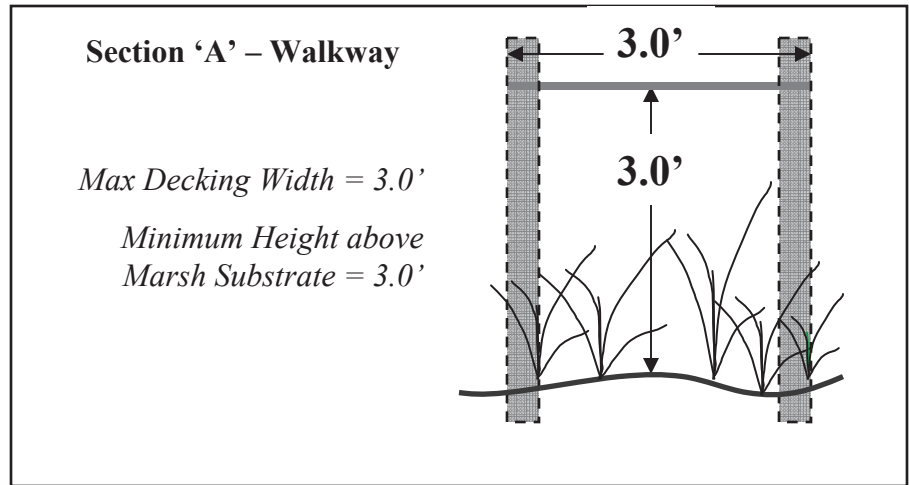
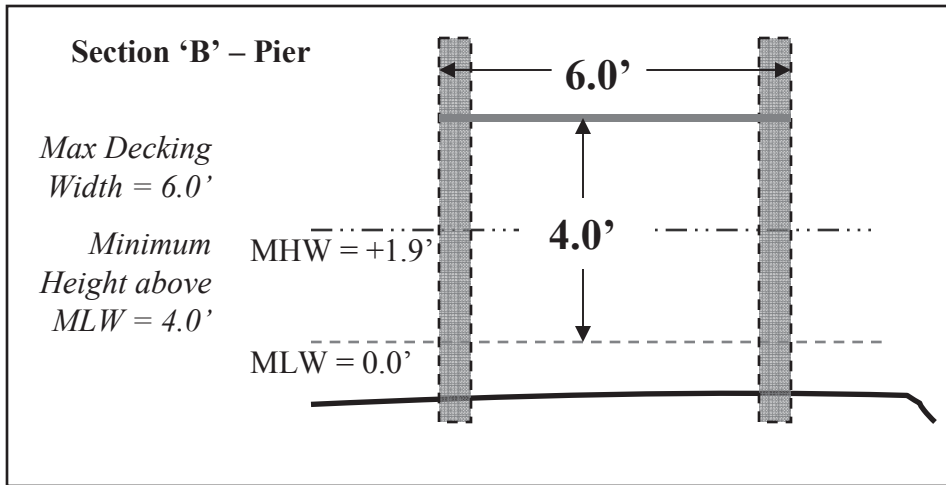
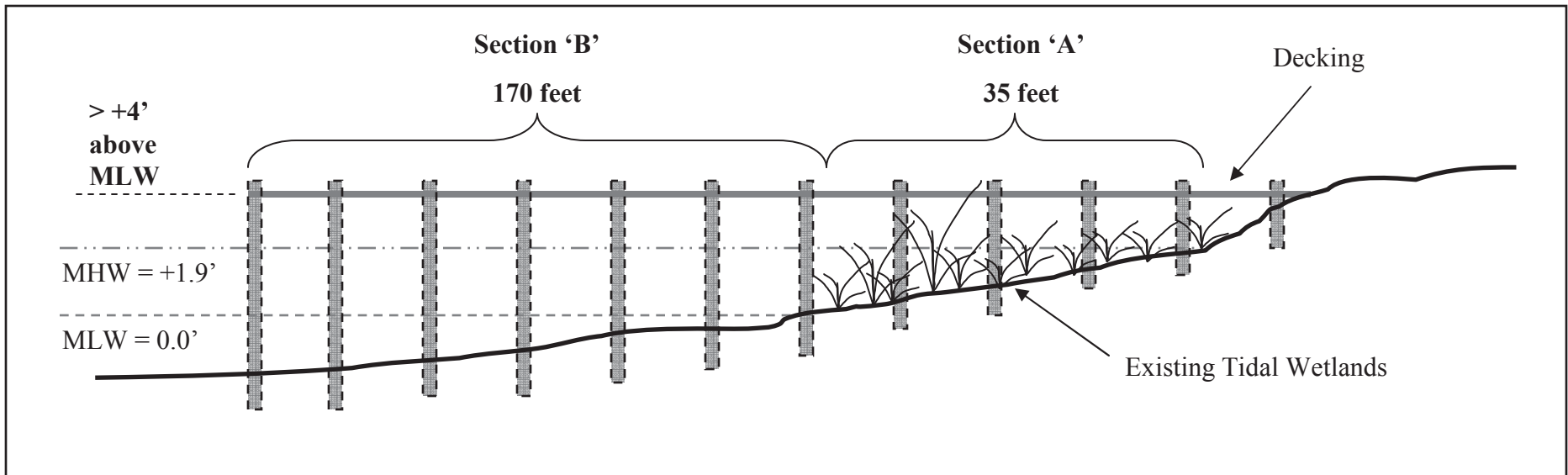

**Pier Project**

Proposed Project Cross-section for:  
 Applicant Name  
 Mailing Address, Town, County, State

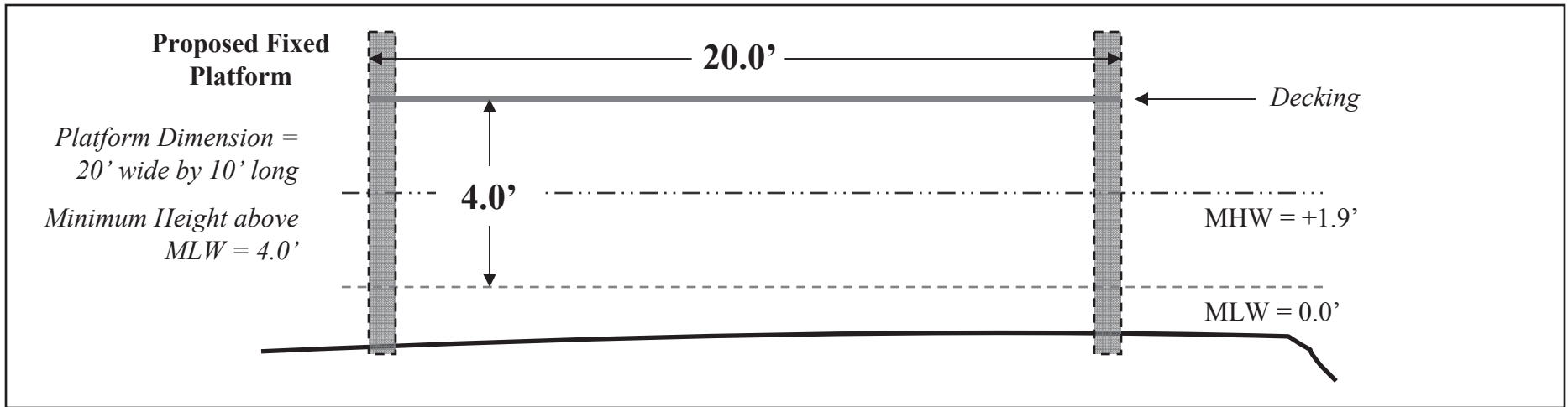
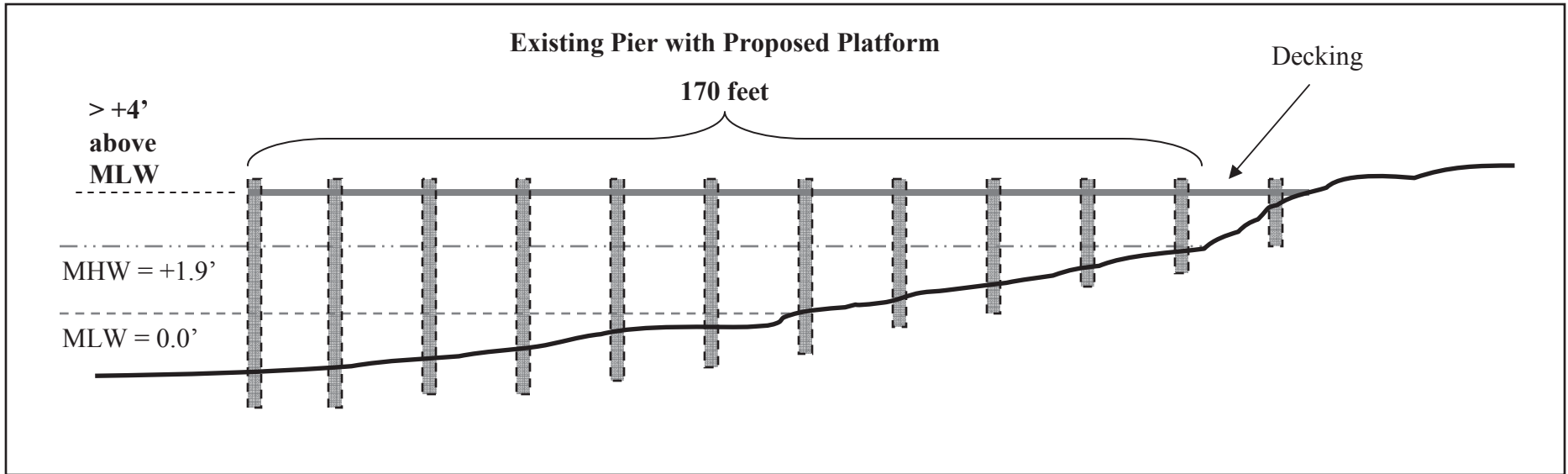

**Platform on Existing Pier Project**

Proposed Project Cross-section for:  
Applicant Name  
Mailing Address, Town, County, State

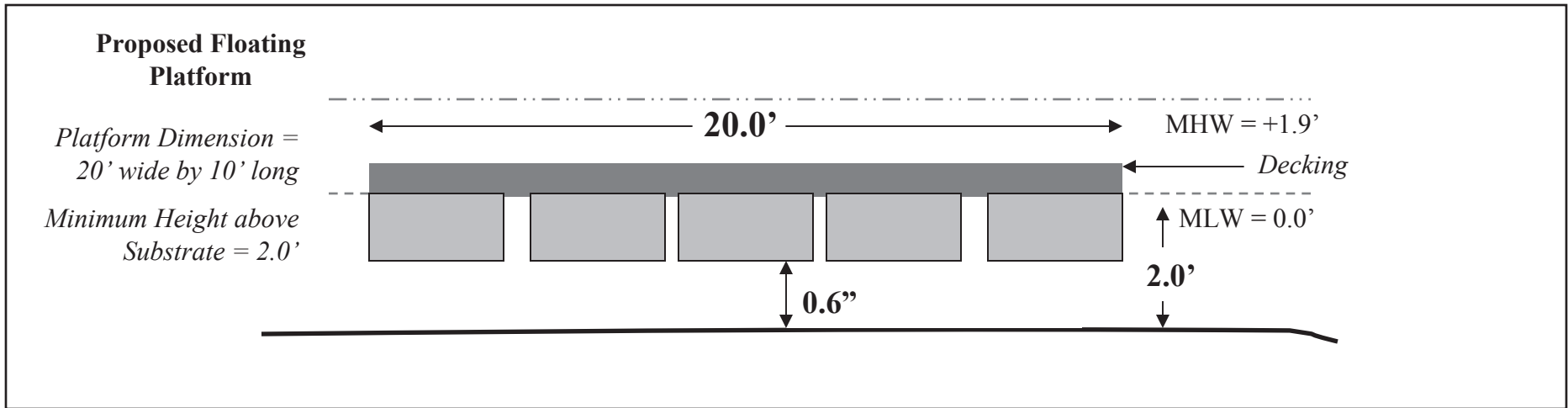
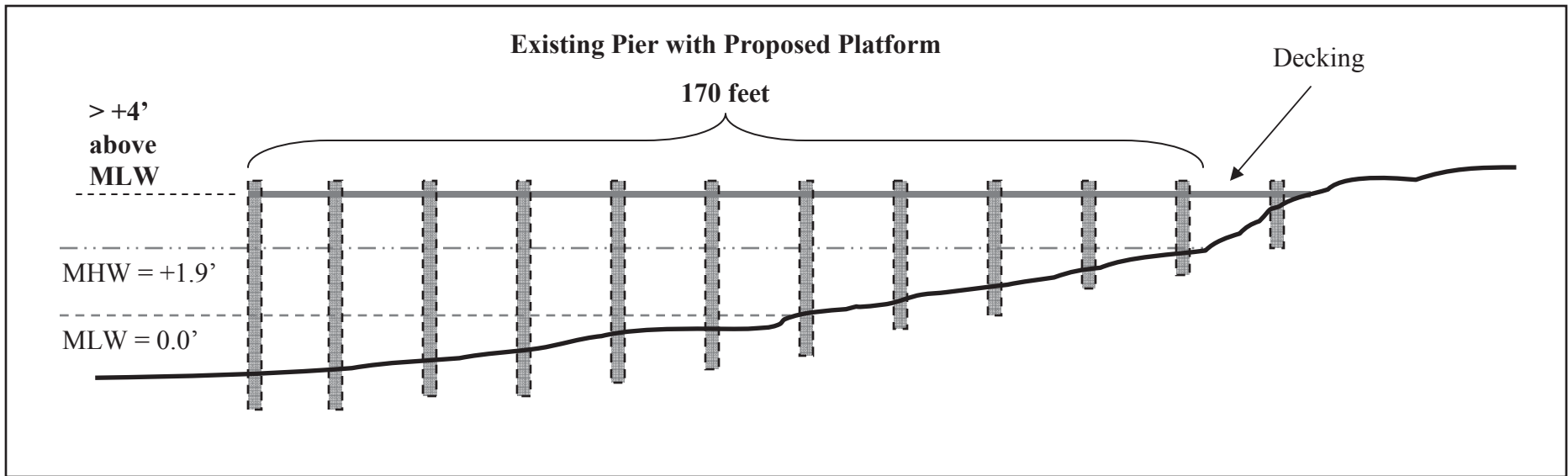

### Platform on Existing Pier Project

Proposed Project Cross-section for:  
 Applicant Name  
 Mailing Address, Town, County, State

DATE, Page X of Y

**WETLANDS AND WATERWAYS PROGRAM  
TIDAL WETLAND APPLICATION GUIDELINES**

**PROPOSED REPLACEMENT BULKHEAD PROJECT**

Check list outlines the minimum required information for a proposed project; additional information may be required based on the project and/or the applicant's project site. Applicants are encouraged to schedule a pre-application meeting to answer questions, discuss the applicant's site, discuss the proposed project, and determine if any additional information/plan sheets are required due to the uniqueness of the applicant's site.

- Requires application processing fee\* (1.5 feet / 18 inches channelward of existing, functional bulkhead)
- Exempt from application processing fee\* (in-kind – replacement in the exact same footprint of existing, functional bulkhead (NO CHANNELWARD ENCROACHMENT) **(In-kind is defined as "...replacement of a structure with a structure of similar materials and dimensions" per COMAR 26.24.01.02A(24) and functionality is defined as 85% per COMAR 26.24.01.02A(20))**)

**\*Reference the fee guidelines and tables to determine appropriate application review fees.**

NOTE: This guideline and sample plans are for the replacement of a bulkhead 1.5 feet/18 inches channelward of a functional, existing bulkhead. It is recommended that an applicant schedule a pre-application visit with MDE to determine if the existing bulkhead is functional according to MDE guidelines. A functional, existing bulkhead may be replaced, otherwise an alternative method of shoreline erosion control must be proposed.

**APPLICATION GUIDELINE**

---

- ABBREVIATED JOINT FEDERAL / STATE APPLICATION FOR THE ALTERATION OF ANY TIDAL WETLAND AND/OR TIDAL WATERS IN MARYLAND
  - Plans
  - Photographs of existing bulkhead
- 

**GENERAL PLAN REQUIREMENTS**

---

- Plan sheets should be on 8.5" x 11" paper, black and white, and single sided; Plans are to be legible and not cluttered; usable written or visual scale no smaller than 1" = 50' on proposed plan sheets and a usable written or visual scale no smaller than 1" = 100' on existing plan sheets. All plan notes should be placed at the bottom of the page or on a separate page. The plan sheets should be numbered to reference the plan sheet in relation to the total number of plan sheets i.e. Page 1 of 3, Page 2 of 3, etc.
- 

**VICINITY MAP & AERIAL PHOTO PLAN SHEET**

---

- Plan sheets should be on 8.5" x 11" paper, black and white, and single sided; Plans are to be legible and not cluttered; All plan notes should be placed at the bottom of the page or on a separate page. The plan sheets should be numbered to reference the plan sheet in relation to the total number of plan sheets i.e. Page 1 of 3, Page 2 of 3, etc.
  - Plan sheet should include the type of projects proposed by applicant i.e. replacement bulkhead.
-

---

## VICINITY MAP & AERIAL PHOTO PLAN SHEET (CONTINUED)

---

- Plan sheet should include the name of the applicant(s) and mailing address including the town/city, county, state, and zip code.
  - Vicinity map and aerial photo should be sized to clearly depict the project site and surround area, but each map should no smaller than 4" by 4" in size.
  - Vicinity map should include a North arrow and be scaled to clearly show project site, general location on the waterway, the immediate surrounding area.
  - Aerial photograph should be no more than 10 years old from date of application.
  - Aerial photograph should, at a minimum, show the proposed project site (clearly marked) with any existing structures and the adjacent property owners' property with any existing structures.
- 

## EXISTING CONDITION PLAN SHEET(S)

---

- Plan sheets should be on 8.5" x 11" paper, black and white, and single sided; Plans are to be legible and not cluttered; usable written or visual scale no smaller than 1" = 100' on existing plan sheets. All plan notes should be placed at the bottom of the page or on a separate page. The plan sheets should be numbered to reference the plan sheet in relation to the total number of plan sheets i.e. Page 1 of 3, Page 2 of 3, etc.
  - Plan sheet should include the type of projects proposed by applicant i.e. replacement bulkhead
  - Plan sheet should include the name of the applicant(s) and mailing address including the town/city, county, state, and zip code.
  - Plan view should include the Mean High Water Line (MHWL) and the Mean Low Water Line (MLWL; referenced to 0.0 feet).
  - Plan view should include water depths marked as either contours or spot depths.
  - Plan view should include the name of the waterway, North arrow, and direction of ebb/flow tide.
  - Plan view should include the property lines (labeled) extended channelward.
  - Plan view should depict the existing bulkhead and include the linear feet of shoreline proposed to be impacted by construction of the replacement bulkhead.
  - Plan view should include the applicant's property and directly adjacent riparian properties clearly labeled with their name, site address, town/city, county, state, and zip code.
  - Plan view should include all existing structures, including vegetated wetlands and SAV, on the applicant's property and adjacent riparian properties.
- 

## PROPOSED CONDITION PLAN SHEET(S)

---

- Plan sheets should be on 8.5" x 11" paper, black and white, and single sided; Plans are to be legible and not cluttered; usable written or visual scale no smaller than 1" = 50' on proposed plan sheets. All plan notes should be placed at the bottom of the page or on a separate page. The plan sheets should be numbered to reference the plan sheet in relation to the total number of plan sheets i.e. Page 1 of 3, Page 2 of 3, etc.
  - Plan sheet should include the type of projects proposed by applicant i.e. replacement bulkhead.
-

---

## PROPOSED CONDITION PLAN SHEET(S) (CONTINUED)

---

- Plan sheet should include the name of the applicant(s) and mailing address including the town/city, county, state, and zip code.
  - Plan view should include the Mean High Water Line (MHWL) and the Mean Low Water Line (MLWL; referenced to 0.0 feet). *If the MHWL or the MLWL are to be altered during construction the proposed MHWL and MLWL should also be labeled.*
  - Plan view should include water depths marked as either contours or spot depths.
  - Plan view should include the name of the waterway, North arrow, and direction of ebb/flow tide.
  - Plan view should include the property lines (labeled) extended channelward.
  - Plan view should depict the existing bulkhead and the proposed replacement bulkhead along the shoreline and accurately depict the maximum channelward encroachment, from the existing bulkhead, along the entire project (1.5 feet/ 18 inches).
  - Plan view should include the applicant's property and any erosion control structures on adjacent riparian properties that will be abutted by the replacement bulkhead.
- 

## CROSS-SECTION PLAN SHEET(S)

---

- Plan sheets should be on 8.5" x 11" paper, black and white, and single sided; Plans are to be legible and not cluttered. All plan notes should be placed at the bottom of the page or on a separate page. The plan sheets should be numbered to reference the plan sheet in relation to the total number of plan sheets i.e. Page 1 of 3, Page 2 of 3, etc.
  - Plan sheet should include the type of projects proposed by applicant i.e. replacement bulkhead.
  - Plan sheet should include the name of the applicant(s) and mailing address including the town/city, county, state, and zip code.
  - Cross-Section views should include the Mean High Water (MHW), the Mean Low Water (MLW; referenced to 0.0 feet), and top of bank. Example: MLW = 0.0', MHW = + 1.9', + 4.0' Top of Bank.
  - Cross-Section should depict existing bank, existing bulkhead (depict sheathing & pilings), proposed bulkhead (depict sheathing & pilings), maximum channelward extent of 1.5 feet/18 inches from existing bulkhead (**1.5 feet/18 inches is measured from the outboard edge of the pilings of the existing bulkhead to the inboard edge of the sheathing of the proposed bulkhead**), any proposed fill landward of the existing and proposed bulkhead, and proposed method to prevent loss of fill material to the waters of the State (i.e. filter cloth).
-



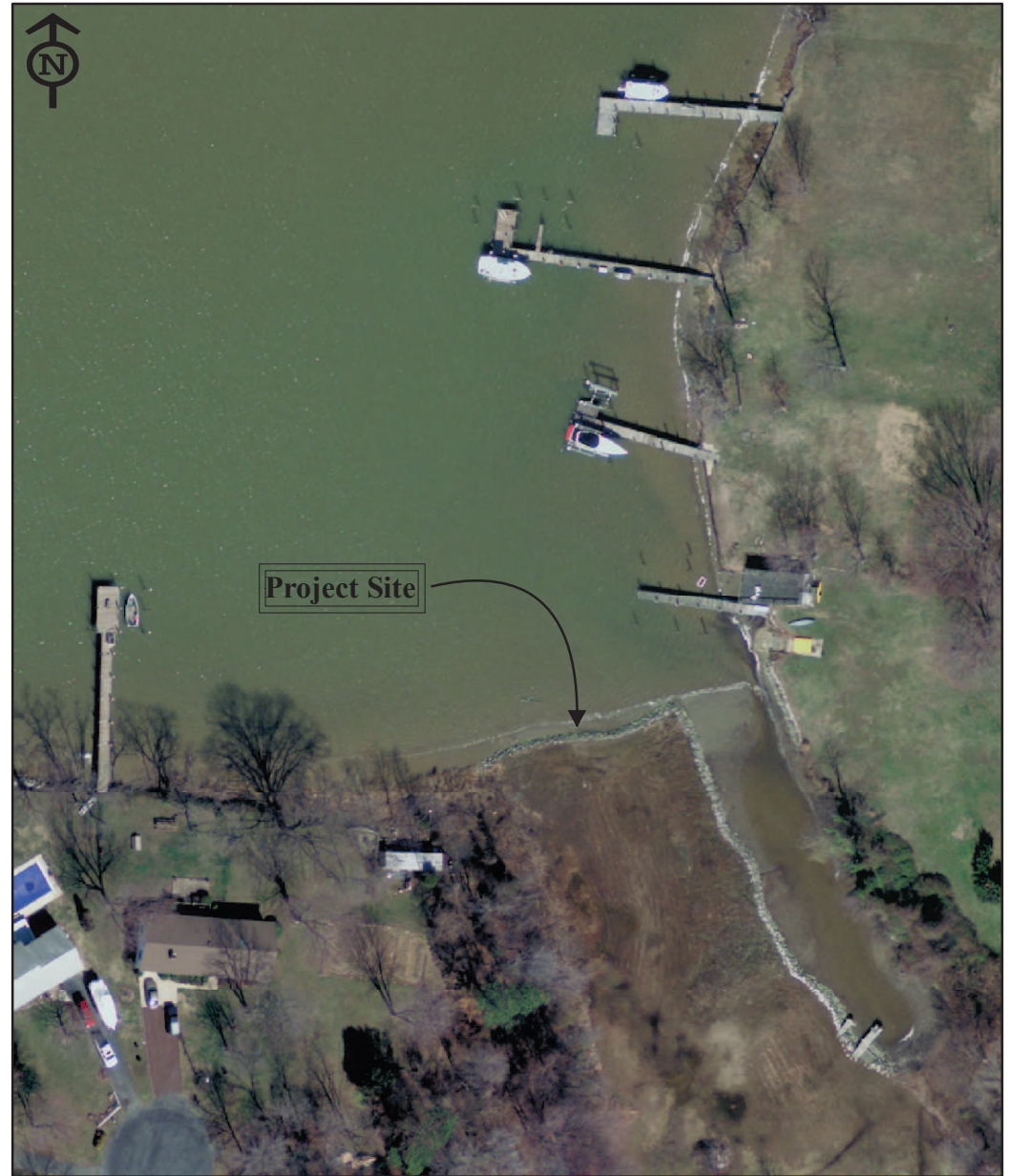
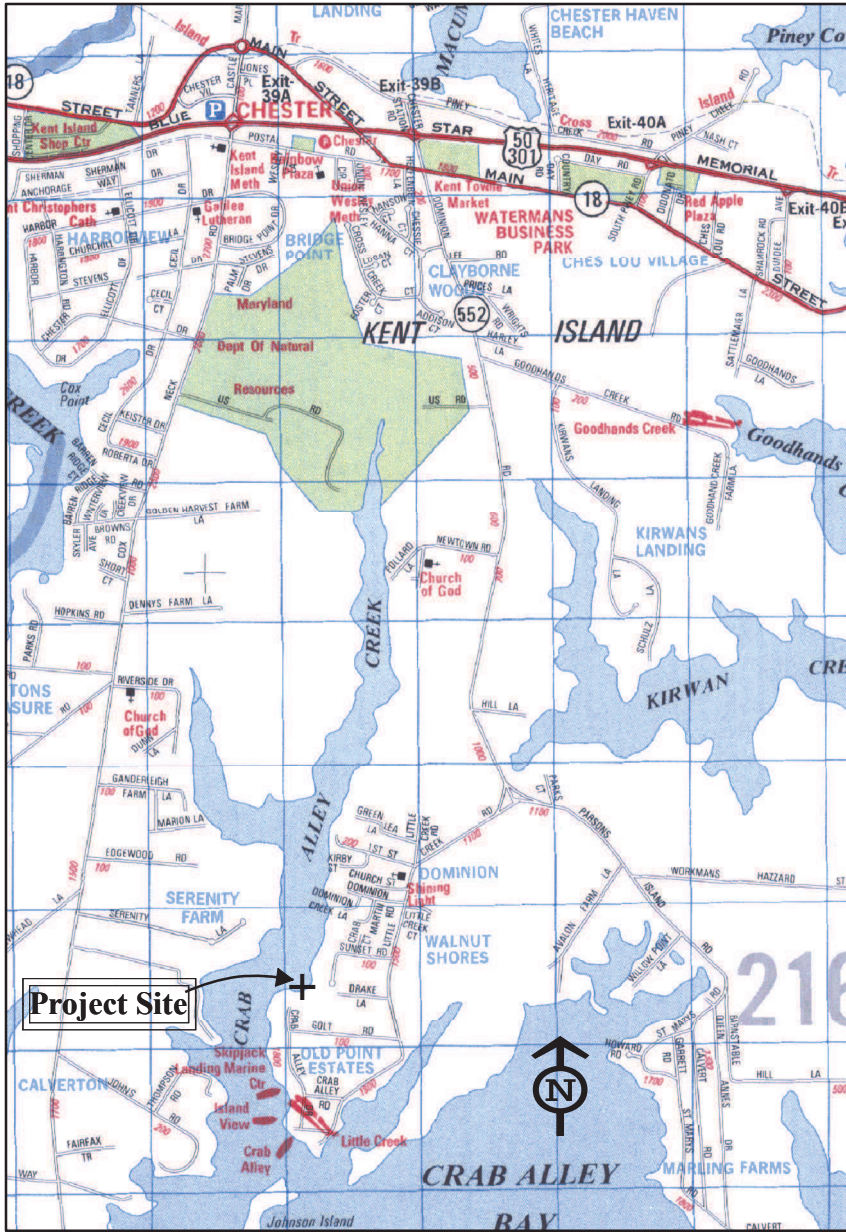

**Vicinity Map & Aerial Photo**

Project: [INSERT TYPE OF PROJECT]

Proposed Project for:  
 Applicant NAME  
 Mailing Address, Town, County, State, Zip Code

NOTES



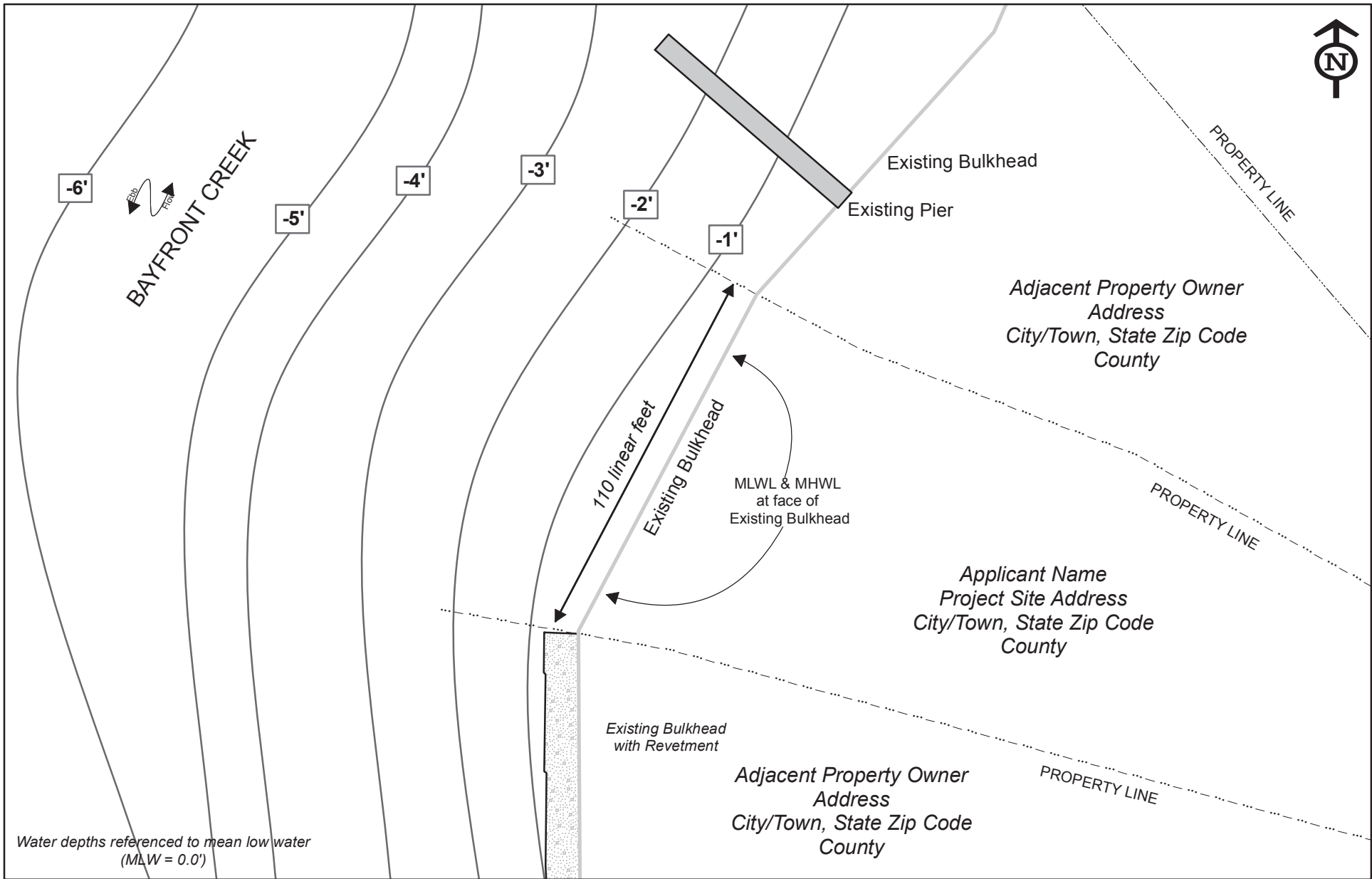

<p><b>Existing Conditions</b></p> <p>Project: Replacement Bulkhead</p> <p>Proposed Project for:</p> <p>Applicant NAME</p> <p>Mailing Address, Town, County, State, Zip Code</p>	<p>0 10 20 40 60 80 100 120 Feet</p> <p>1 inch = 40 feet</p>	<p><b>PROJECT NOTES:</b></p> <p>Existing Structure</p> <p><b>DATE, Page X of Y</b></p>
---	--	--

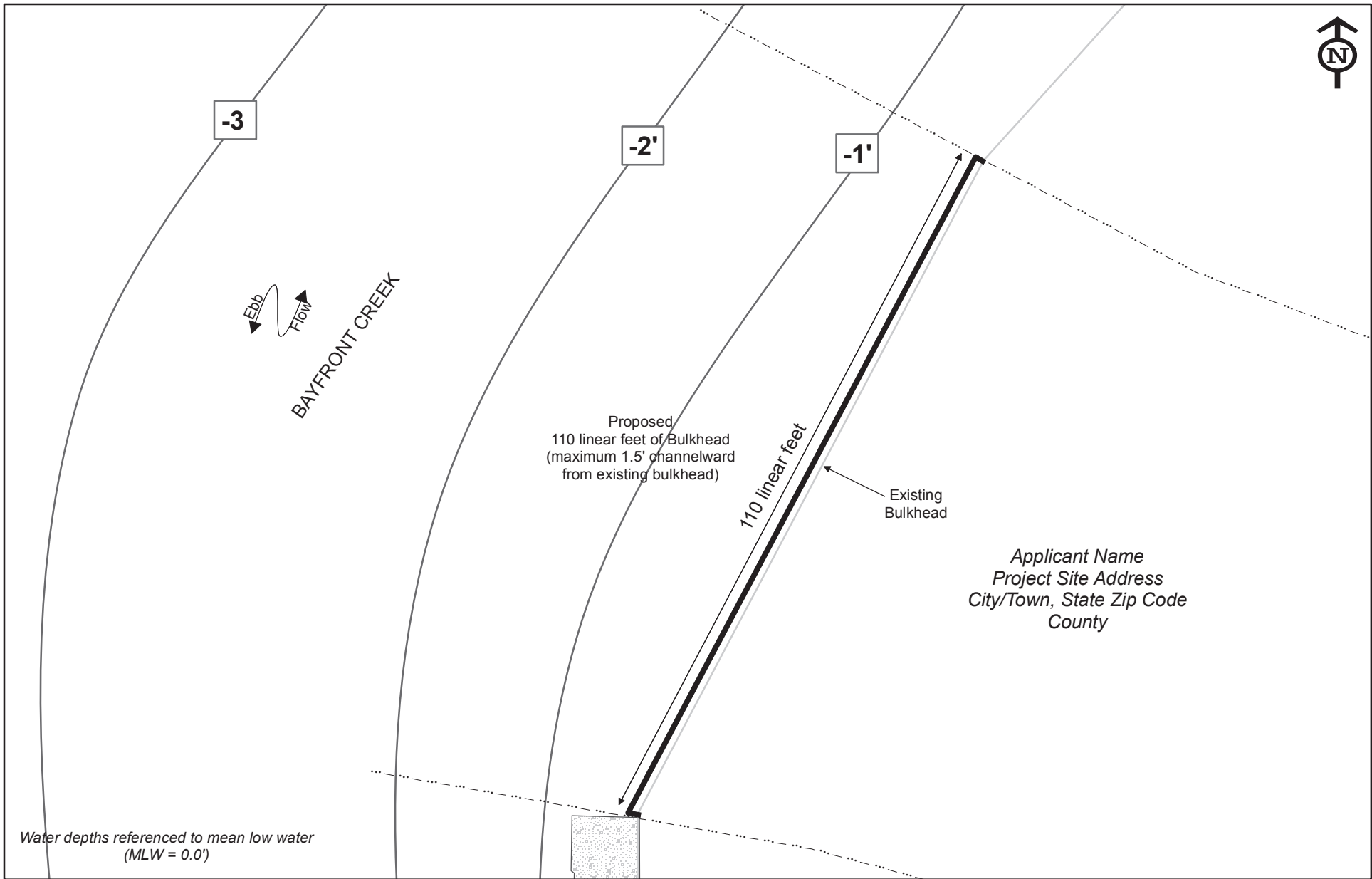

**Proposed Conditions**

Project: Replacement Bulkhead

Proposed Project for:

Applicant NAME

Mailing Address, Town, County, State, Zip Code

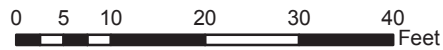

1 inch = 20 feet

**PROJECT NOTES:**

- Existing Structure
- Proposed Structure

**DATE, Page X of Y**

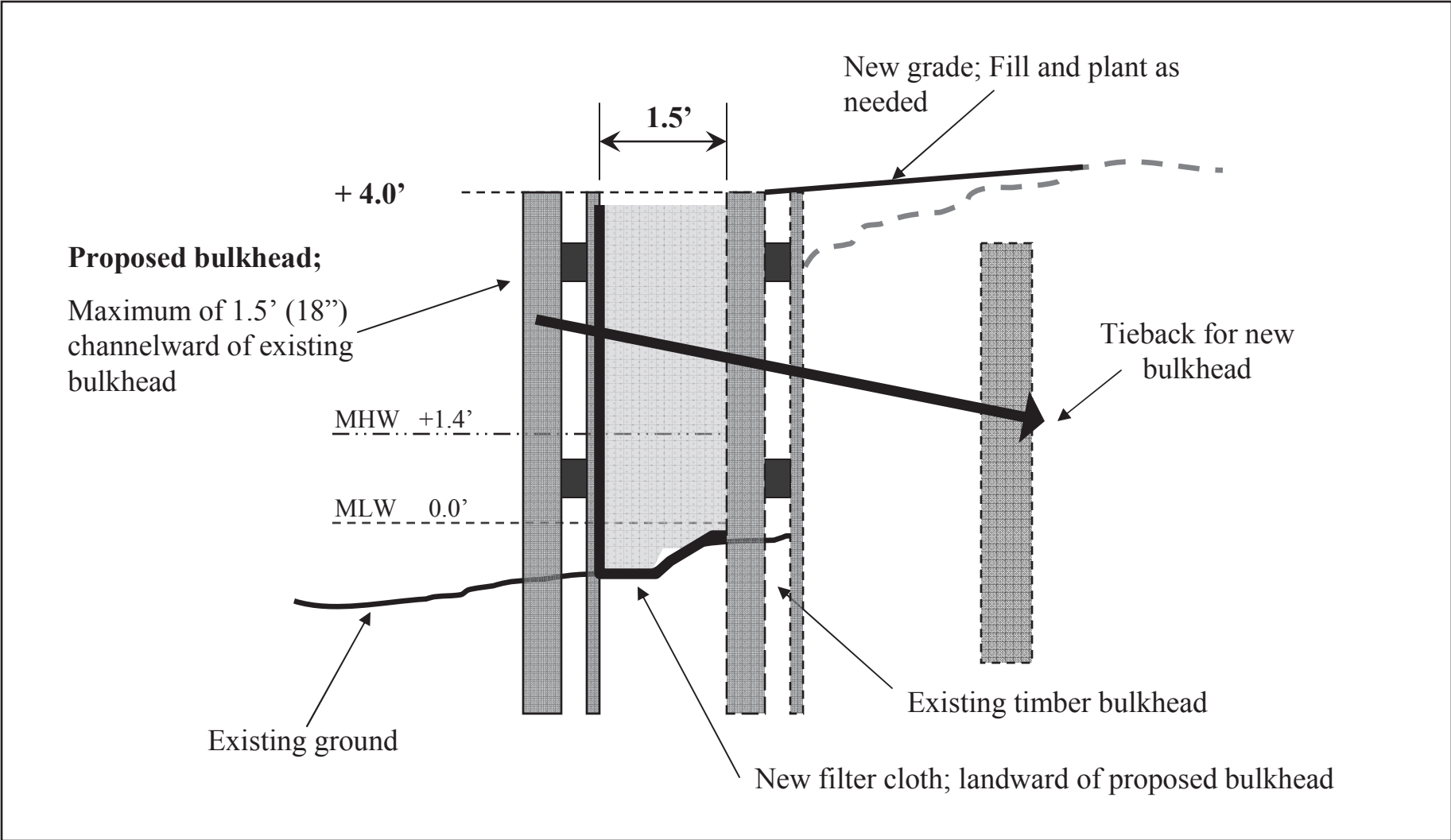

**Project: Replacement Bulkhead**

**PROJECT NOTES:**

Proposed Project Cross-section for:  
Applicant Name  
Mailing Address, Town, County, State

110 Linear Feet of Replacement Bulkhead,  
constructed no more than 1.5-feet (18")  
channelward of existing structure.

DATE, Page X of Y

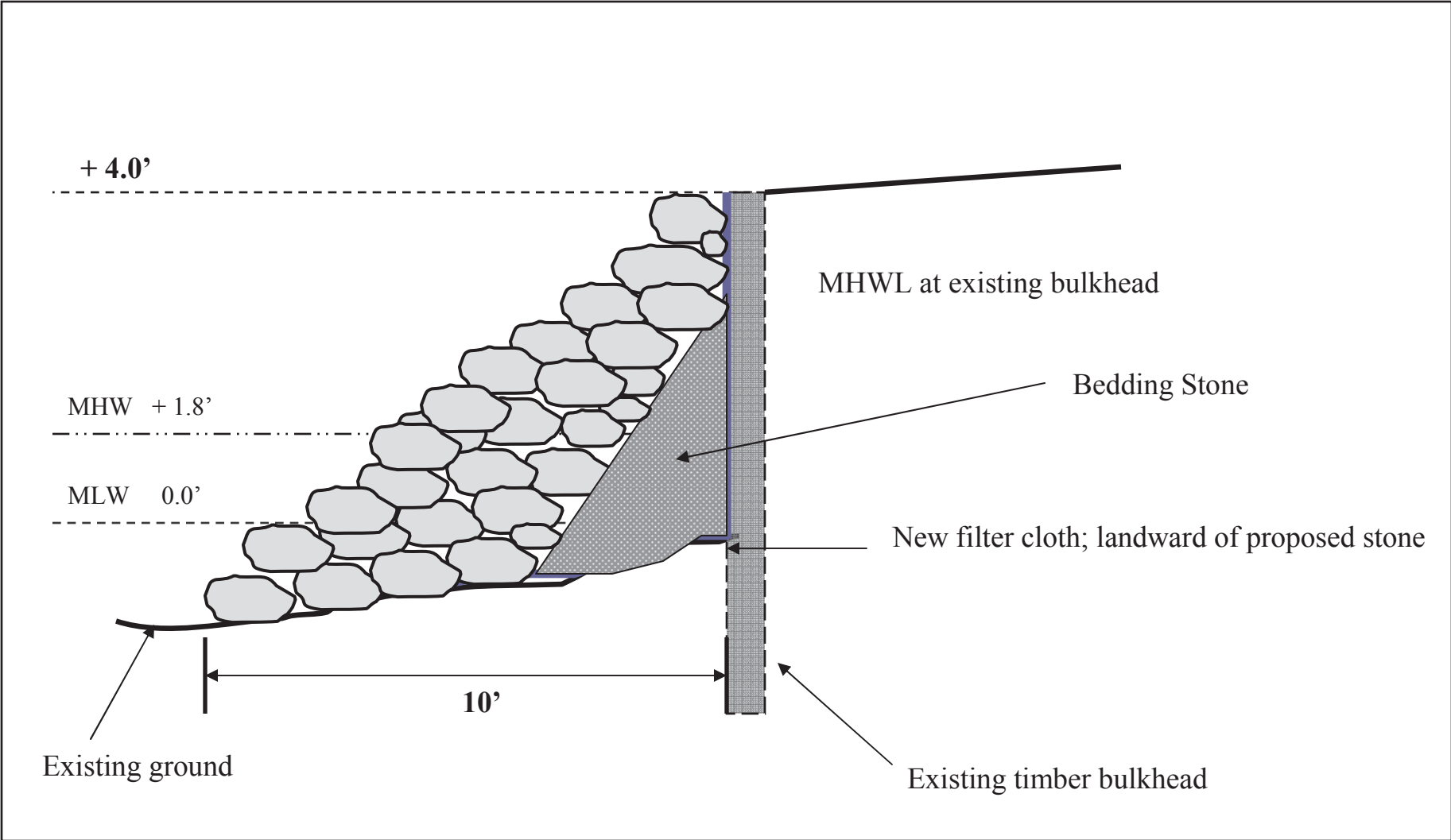

**Project: Stone Revetment Channelward of Existing Bulkhead**

Proposed Project:

Proposed Project Applicant:  
 Applicant Name  
 Mailing Address, Town, County, State

NOTES: XXX Linear Feet of Stone  
 Revetment extending X feet channelward  
 of an existing Bulkhead

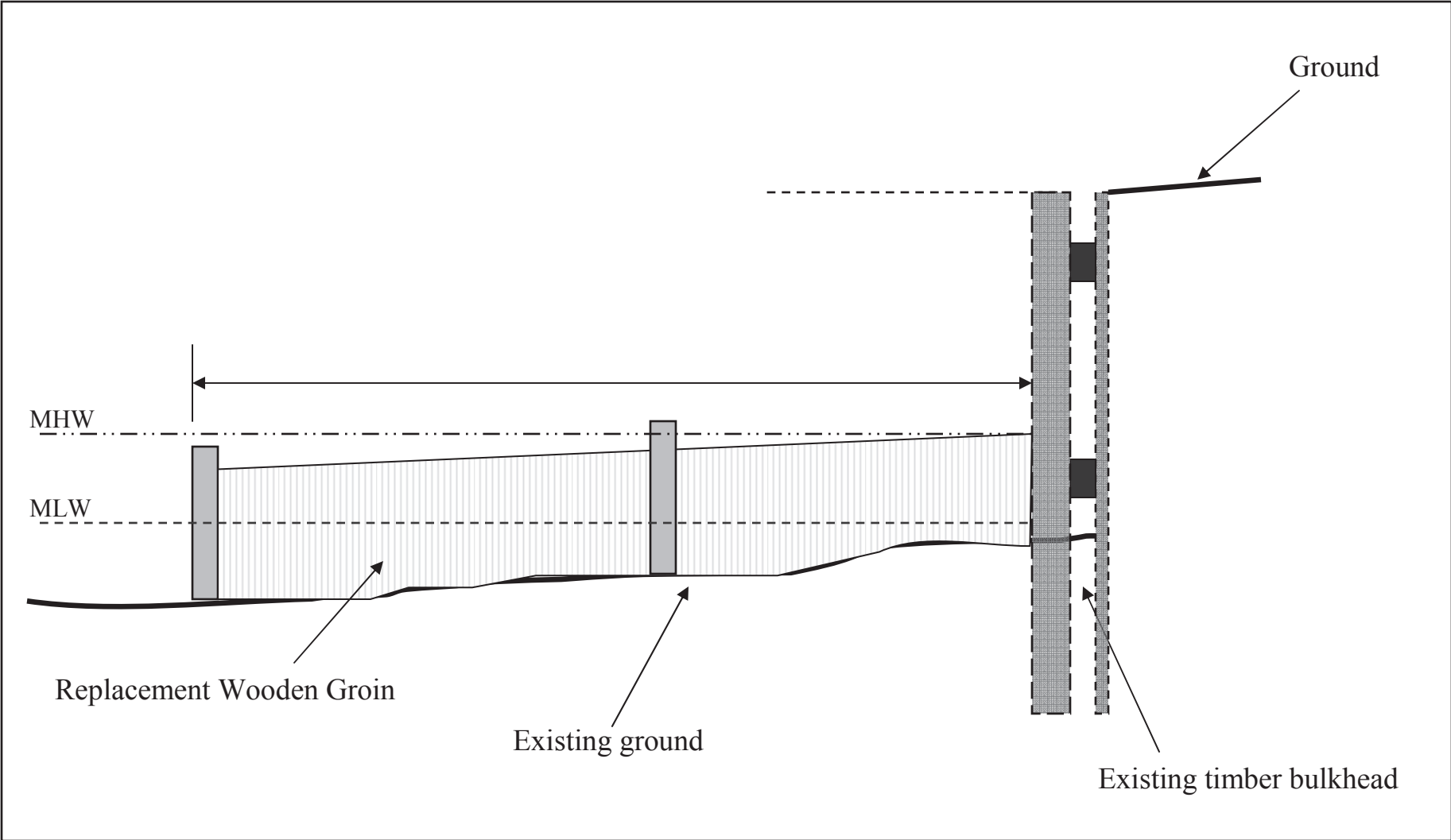

**Project: Replacement Wooden Groin**

**on Existing Bulkhead**

Proposed Project Cross-section for:  
Applicant Name  
Address, City, Zipcode

**WETLANDS AND WATERWAYS PROGRAM  
TIDAL WETLAND APPLICATION GUIDELINES**

**PROPOSED REVETMENT PROJECT**

Check list outlines the minimum required information for a proposed project; additional information may be required based on the project and/or the applicant's project site. Applicants are encouraged to schedule a pre-application meeting to answer questions, discuss the applicant's site, discuss the proposed project, and determine if any additional information/plan sheets are required due to the uniqueness of the applicant's site.

- Requires application processing fee
- Exempt from application processing fee

**\*Reference the fee guidelines and tables to determine appropriate application review fees.**

**GENERAL PLAN REQUIREMENTS**

---

- Plan sheets should be on 8.5" x 11" paper, black and white, and single sided; Plans are to be legible and not cluttered; usable written or visual scale no smaller than 1" = 50' on proposed plan sheets and a usable written or visual scale no smaller than 1" = 100' on existing plan sheets. All plan notes should be placed at the bottom of the page or on a separate page. The plan sheets should be numbered to reference the plan sheet in relation to the total number of plan sheets i.e. Page 1 of 3, Page 2 of 3, etc.
- 

**VICINITY MAP & AERIAL PHOTO PLAN SHEET**

---

- Plan sheets should be on 8.5" x 11" paper, black and white, and single sided; Plans are to be legible and not cluttered; All plan notes should be placed at the bottom of the page or on a separate page. The plan sheets should be numbered to reference the plan sheet in relation to the total number of plan sheets i.e. Page 1 of 3, Page 2 of 3, etc.
  - Plan sheet should include the type of projects proposed by applicant i.e. revetment.
  - Plan sheet should include the name of the applicant(s) and mailing address including the town/city, county, state, and zip code.
  - Vicinity map and aerial photo should be sized to clearly depict the project site and surround area, but each map should no smaller than 4" by 4" in size.
  - Vicinity map should include a North arrow and be scaled to clearly show project site, general location on the waterway, the immediate surrounding area.
  - Aerial photograph should be no more than 10 years old from date of application.
  - Aerial photograph should, at a minimum, show the proposed project site (clearly marked) with any existing structures and the adjacent property owners' property with any existing structures.
- 

**EXISTING CONDITION PLAN SHEET(S)**

---

- Plan sheets should be on 8.5" x 11" paper, black and white, and single sided; Plans are to be legible and not cluttered; usable written or visual scale no smaller than 1" = 100' on existing plan sheets. All plan notes should be placed at the bottom of the page or on a separate page. The plan sheets should be numbered to reference the plan sheet in relation to the total number of plan sheets i.e. Page 1 of 3, Page 2 of 3, etc.
  - Plan sheet should include the type of projects proposed by applicant i.e. revetment.
-



## EXISTING CONDITION PLAN SHEET(S) (CONTINUED)

---

- Plan sheet should include the name of the applicant(s) and mailing address including the town/city, county, state, and zip code.
  - Plan view should include the Mean High Water Line (MHWL) and the Mean Low Water Line (MLWL; referenced to 0.0 feet).
  - Plan view should include water depths marked as either contours or spot depths.
  - Plan view should include the name of the waterway, North arrow, and direction of ebb/flow tide.
  - Plan view should include the property lines (labeled) extended channelward.
  - Plan view should include the linear feet of shoreline proposed to be impacted by construction of the revetment.
  - Plan view should include the applicant's property and directly adjacent riparian properties clearly labeled with their name, site address, town/city, county, state, and zip code.
  - Plan view should include all existing structures, including vegetated wetlands and SAV, on the applicant's property and adjacent riparian properties.
- 

## PROPOSED CONDITION PLAN SHEET(S)

---

- Plan sheets should be on 8.5" x 11" paper, black and white, and single sided; Plans are to be legible and not cluttered; usable written or visual scale no smaller than 1" = 50' on proposed plan sheets. All plan notes should be placed at the bottom of the page or on a separate page. The plan sheets should be numbered to reference the plan sheet in relation to the total number of plan sheets i.e. Page 1 of 3, Page 2 of 3, etc.
  - Plan sheet should include the type of projects proposed by applicant i.e. revetment.
  - Plan sheet should include the name of the applicant(s) and mailing address including the town/city, county, state, and zip code.
  - Plan view should include the Mean High Water Line (MHWL) and the Mean Low Water Line (MLWL; referenced to 0.0 feet). *If the MHWL or the MLWL are to be altered during construction the proposed MHWL and MLWL should also be labeled.*
  - Plan view should include water depths marked as either contours or spot depths that extend across the width of the waterway.
  - Plan view should include the name of the waterway, North arrow, and direction of ebb/flow tide.
  - Plan view should include the property lines (labeled) extended channelward.
  - Plan view should depict the proposed revetment along shoreline proposed to be impacted by construction and accurately depict the max channelward encroachment along the entire project.
  - Plan view should include the applicant's property and any erosion control structures on adjacent riparian properties that will be abutted by the revetment.
-

## CROSS-SECTION PLAN SHEET(S)

---

- Plan sheets should be on 8.5" x 11" paper, black and white, and single sided; Plans are to be legible and not cluttered. All plan notes should be placed at the bottom of the page or on a separate page. The plan sheets should be numbered to reference the plan sheet in relation to the total number of plan sheets i.e. Page 1 of 3, Page 2 of 3, etc.

---

- Plan sheet should include the type of projects proposed by applicant i.e. revetment.

---

- Plan sheet should include the name of the applicant(s) and mailing address including the town/city, county, state, and zip code.

---

- Cross-Section views should include the Mean High Water (MHW), the Mean Low Water (MLW; referenced to 0.0 feet), and top of bank. Example: MLW = 0.0', MHW = + 1.9', + 4.0' Top of Bank.

---

- Existing Cross-Section should depict existing bank and slope.

---

- Proposed Cross-Section should depict the proposed revetment, any grading and fill necessary for construction, maximum channelward encroachment from the Mean High Water (MHW), the material used to prevent the loss of fill material to the waters of the State i.e. filter cloth, and the slope of revetment.

---

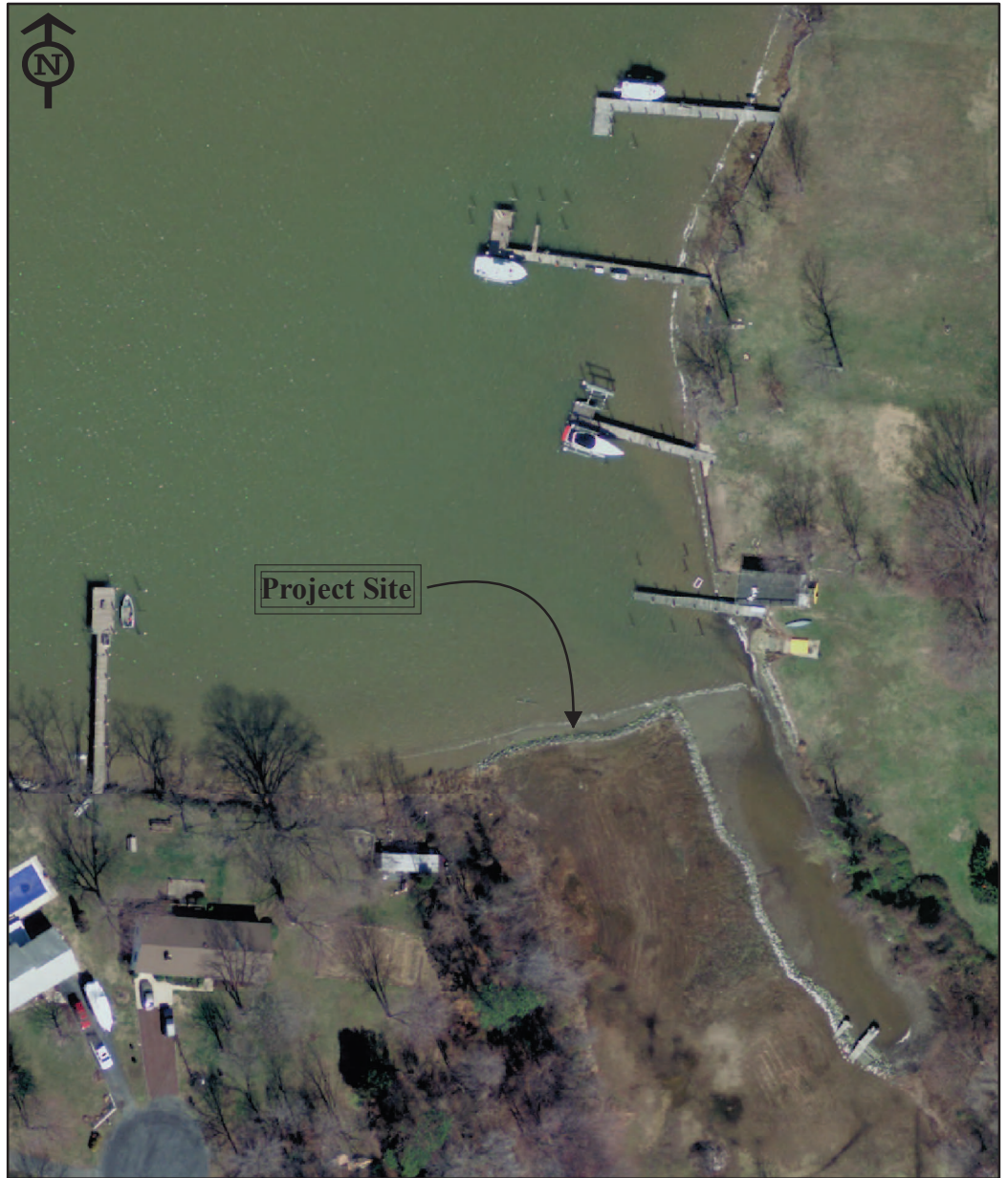
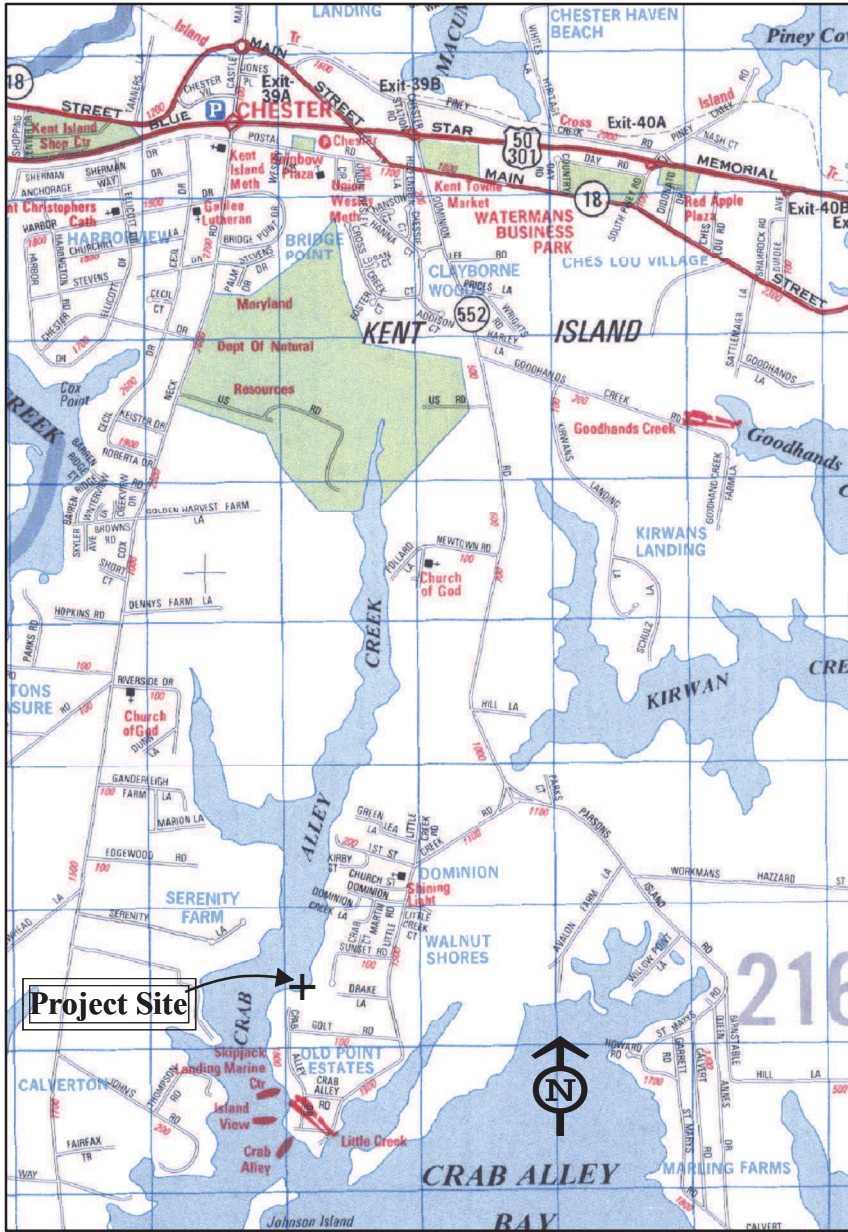

**Vicinity Map & Aerial Photo**

Project: [INSERT TYPE OF PROJECT]

Proposed Project for:  
 Applicant NAME  
 Mailing Address, Town, County, State, Zip Code

NOTES

DATE, Page X of Y



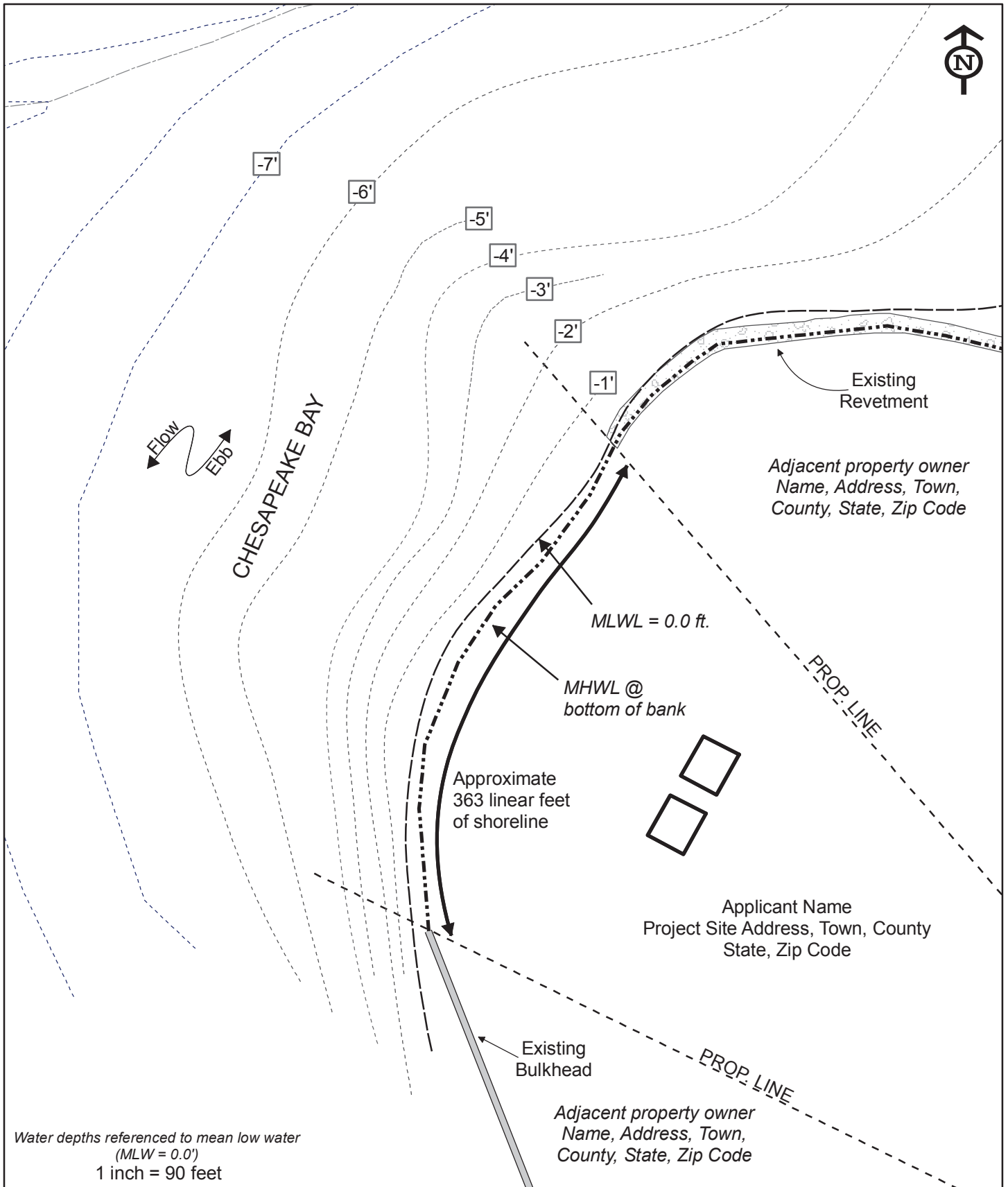

**Existing Conditions**

Project: Revetment

Proposed Project for:

Applicant NAME

Mailing Address, Town, County, State, Zip Code



PROJECT NOTES:



DATE, Page X of Y

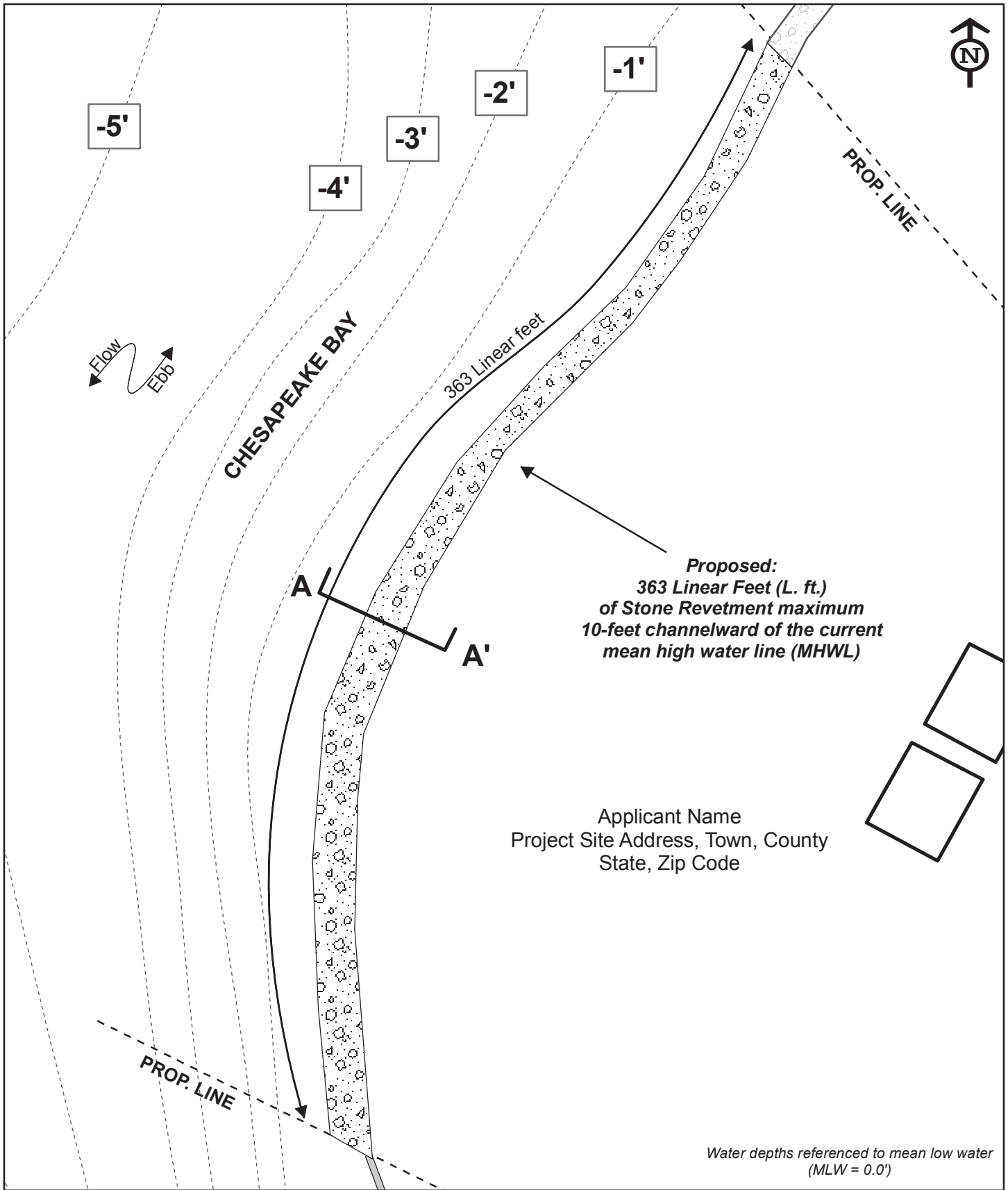

**Proposed Conditions**

Project: Revetment



1 inch = 40 feet

**PROJECT NOTES:**

Proposed Project for:  
Applicant NAME  
Mailing Address, Town, County, State, Zip Code

- Existing Structure
- Proposed Structure

DATE, Page X of Y

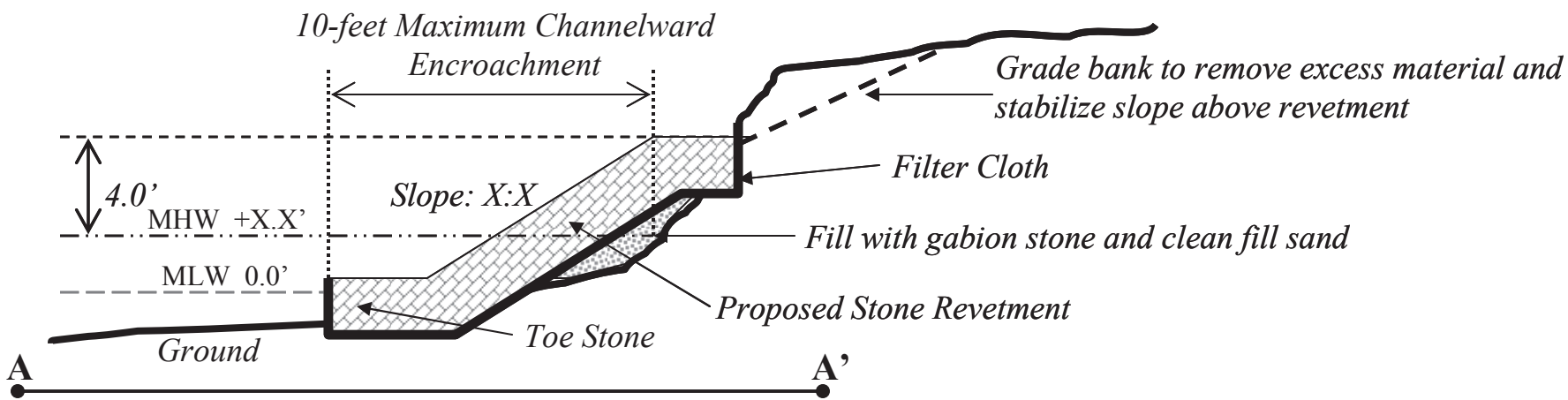
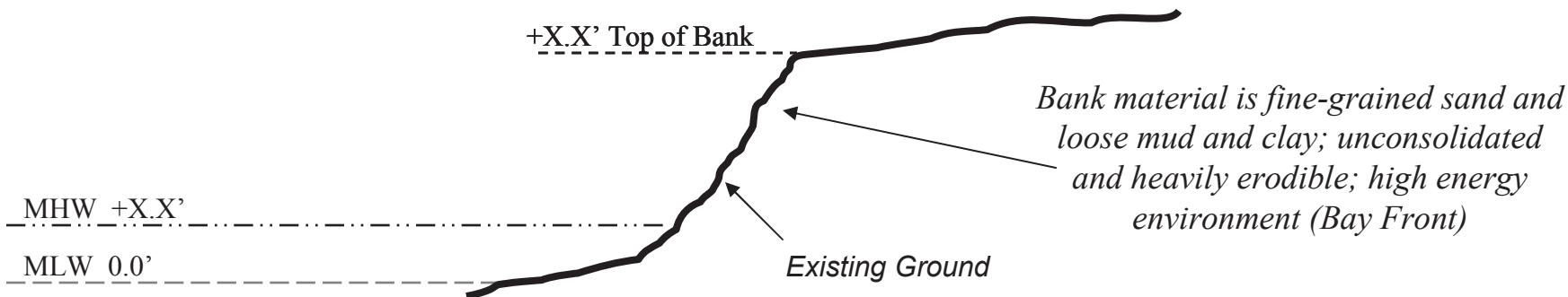

**Project: Revetment**

NOTES: Class of stone used, clean fill

Proposed Project Cross-section for:  
 Applicant Name  
 Mailing Address, Town, County, State

DATE, Page X of Y



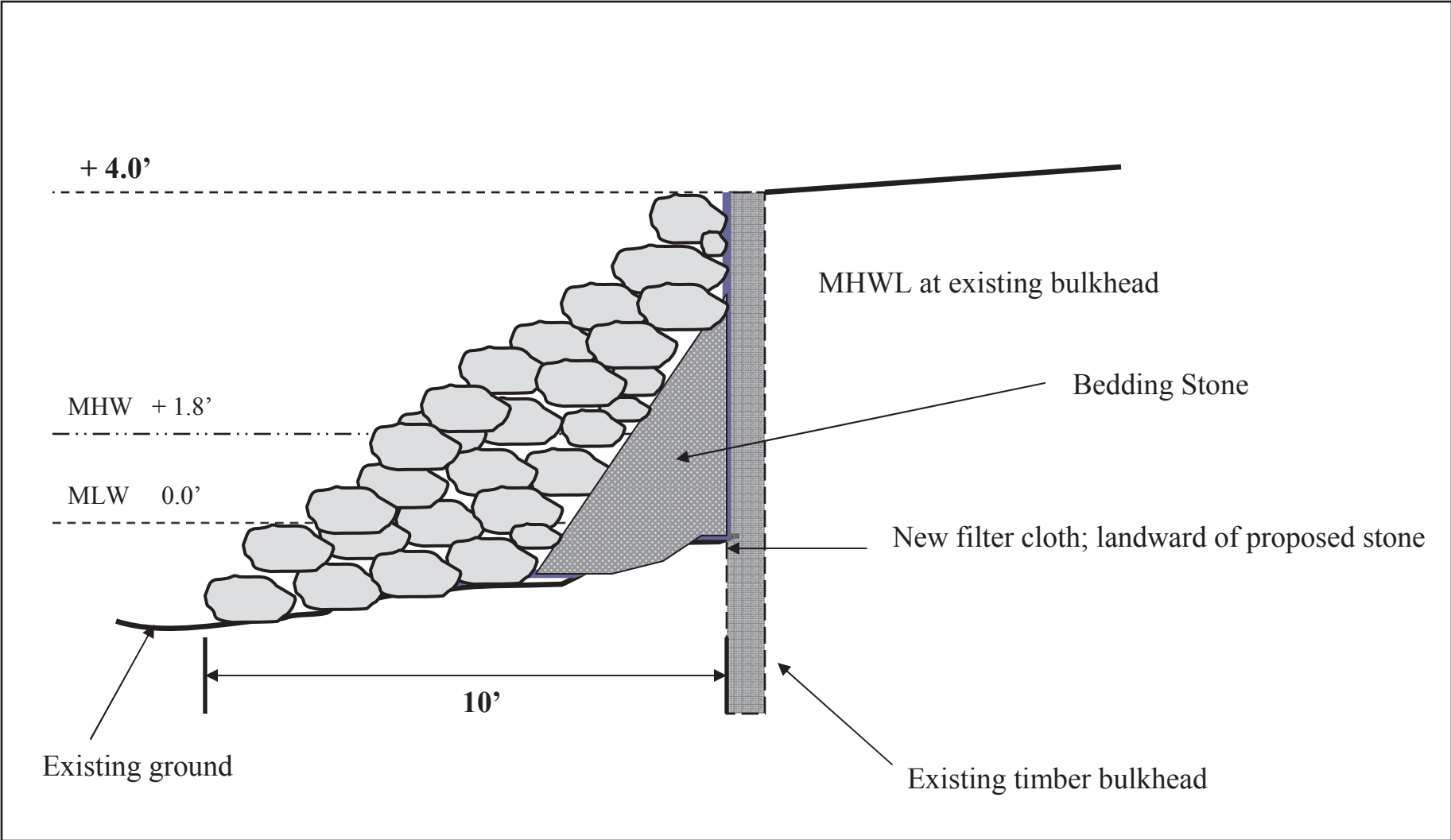

**Project: Stone Revetment Channelward of Existing Bulkhead**

Proposed Project:

Proposed Project Applicant:  
 Applicant Name  
 Mailing Address, Town, County, State

NOTES: XXX Linear Feet of Stone  
 Revetment extending X feet channelward  
 of an existing Bulkhead

**WETLANDS AND WATERWAYS PROGRAM  
TIDAL WETLAND APPLICATION GUIDELINES**

**PROPOSED LIVING SHORELINE PROJECT**

Check list outlines the minimum required information for a proposed project; additional information may be required based on the project and/or the applicant's project site. Applicants are encouraged to schedule a pre-application meeting to answer questions, discuss the applicant's site, discuss the proposed project, and determine if any additional information/plan sheets are required due to the uniqueness of the applicant's site.

- Exempt from application processing fee (**No other project types are proposed at applicant's site**)
- Requires application processing fee (other project types proposed in conjunction with living shoreline i.e. living shoreline & revetment, living shoreline & pier, etc)

**\*Reference the fee guidelines and tables to determine appropriate application review fees.**

**GENERAL PLAN REQUIREMENTS**

---

- Plan sheets should be on 8.5" x 11" paper, black and white, and single sided; Plans are to be legible and not cluttered; usable written or visual scale no smaller than 1" = 50' on proposed plan sheets and a usable written or visual scale no smaller than 1" = 100' on existing plan sheets. All plan notes should be placed at the bottom of the page or on a separate page. The plan sheets should be numbered to reference the plan sheet in relation to the total number of plan sheets i.e. Page 1 of 3, Page 2 of 3, etc.
- 

**VICINITY MAP & AERIAL PHOTO PLAN SHEET**

---

- Plan sheet should include the type of projects proposed by applicant i.e. living shoreline.
  - Plan sheet should include the name of the applicant(s) and mailing address including the town/city, county, state, and zip code.
  - Vicinity map and aerial photo should be sized to clearly depict the project site and surround area, but each map should no smaller than 4" by 4" in size.
  - Vicinity map should include a North arrow and be scaled to clearly show project site, general location on the waterway, the immediate surrounding area.
  - Aerial photograph should be no more than 10 years old from date of application.
  - Aerial photograph should, at a minimum, show the proposed project site (clearly marked) with any existing structures and the adjacent property owners' property with any existing structures.
- 

**PROJECT AREA CONDITIONS PLAN SHEET(S)**

---

- Plan sheets should be on 8.5" x 11" paper, black and white, and single sided; Plans are to be legible and not cluttered; usable visual scaled appropriate for area of project vs. 8.5" x 11" sheet. All plan notes should be placed at the bottom of the page or on a separate page. The plan sheets should be numbered to reference the plan sheet in relation to the total number of plan sheets i.e. Page 1 of 3, Page 2 of 3, etc.
- Plan sheet should include the type of projects proposed by applicant i.e. living shoreline.
- Plan sheet should include the name of the applicant(s) and mailing address including the town/city, county, state, and zip code.

## PROJECT AREA CONDITIONS PLAN SHEET(S) (CONTINUED)

- Plan sheet should include the Mean High Water Line (MHWL) of project's shoreline and the MHWL of the opposite shoreline reflecting the maximum fetch.
- Plan sheet should include the name of the waterway, North arrow, and direction of ebb/flow tide.
- Plan sheet should include the maximum fetch.
- Plan sheet should include the property lines (labeled) extended channelward.

## EXISTING CONDITION PLAN SHEET(S)

- Plan sheets should be on 8.5" x 11" paper, black and white, and single sided; Plans are to be legible and not cluttered; usable written or visual scale no smaller than 1" = 100' on existing plan sheets. All plan notes should be placed at the bottom of the page or on a separate page. The plan sheets should be numbered to reference the plan sheet in relation to the total number of plan sheets i.e. Page 1 of 3, Page 2 of 3, etc.
- Plan sheet should include the type of projects proposed by applicant i.e. living shoreline.
- Plan sheet should include the name of the applicant(s) and mailing address including the town/city, county, state, and zip code.
- Plan view should include the Mean High Water Line (MHWL) and the Mean Low Water Line (MLWL; referenced to 0.0 feet).
- Plan view should include water depths marked as either contours or spot depths that extend channelward a minimum of 100 feet channelward of the Mean High Water Line (MHWL) or 100 feet channelward of the channelward most proposed structure.
- Plan view should include the name of the waterway, North arrow, and direction of ebb/flow tide.
- Plan view should include the property lines (labeled) extended channelward.
- Plan view should include the linear feet of shoreline proposed to be impacted by construction of the living shoreline.
- Plan view should include the applicant's property and directly adjacent riparian properties clearly labeled with their name, site address, town/city, county, state, and zip code.
- Plan view should include all existing structures, including vegetated wetlands and SAV, on the applicant's property and adjacent riparian properties.

## PROPOSED CONDITION PLAN SHEET(S)

- Plan sheets should be on 8.5" x 11" paper, black and white, and single sided; Plans are to be legible and not cluttered; usable written or visual scale no smaller than 1" = 50' on proposed plan sheets. All plan notes should be placed at the bottom of the page or on a separate page. The plan sheets should be numbered to reference the plan sheet in relation to the total number of plan sheets i.e. Page 1 of 3, Page 2 of 3, etc.
- Plan sheet should include the type of projects proposed by applicant i.e. living shoreline.
- Plan sheet should include the name of the applicant(s) and mailing address including the town/city, county, state, and zip code.

## PROPOSED CONDITION PLAN SHEET(S) (CONTINUED)

- 
- Plan view should include the Mean High Water Line (MHWL) and the Mean Low Water Line (MLWL; referenced to 0.0 feet). *If the MHWL or the MLWL are to be altered during construction the proposed MHWL and MLWL should also be labeled.*

---

  - Plan view should include the name of the waterway, North arrow, and direction of ebb/flow tide.

---

  - Plan view should include the property lines (labeled) extended channelward.

---

  - Plan view should depict the linear feet of shoreline proposed to be impacted by construction and accurately depict the max channelward encroachment along the entire project.

---

  - Plan view should include the applicant's property and any erosion control structures on adjacent riparian properties that may be abutted by the sill or groin structures.

---

  - Plan view should clearly depict the area of low marsh plantings, the area of high marsh plantings, the species of plant in each area, and the channelward extent.

---

  - Plan view should clearly depict the channelward extent of any proposed sand containment structure i.e. low profile sill or groin structures and any window openings associated with each structure.
- 

## CROSS-SECTION PLAN SHEET(S)

- 
- Plan sheets should be on 8.5" x 11" paper, black and white, and single sided; Plans are to be legible and not cluttered. All plan notes should be placed at the bottom of the page or on a separate page. The plan sheets should be numbered to reference the plan sheet in relation to the total number of plan sheets i.e. Page 1 of 3, Page 2 of 3, etc.

---

  - Plan sheet should include the type of projects proposed by applicant i.e. living shoreline.

---

  - Plan sheet should include the name of the applicant(s) and mailing address including the town/city, county, state, and zip code.

---

  - Cross-Section views should include the Mean High Water (MHW), the Mean Low Water (MLW; referenced to 0.0 feet), and top of the proposed sill or proposed groin. Example: MLW = 0.0', MHW = + 1.9', + 2.4' Top of sill.

---

  - Proposed Living Shoreline Cross-Section(s) should depict existing bank and slope, proposed slope (including slope ratio) and fill area, existing and proposed Mean High Water Line (MHWL), depiction of proposed sill or groin with channelward extent, proposed low marsh with channelward extent, proposed high marsh with channelward extent, and species of plant proposed to be planted in each area.

---

  - Proposed Sill Opening Cross-Section(s) should include the Mean High Water (MHW), the Mean Low Water (MLW; referenced to 0.0 feet), and top of the proposed sill or proposed groin. Example: MLW = 0.0', MHW = + 1.9', + 2.4' Top of sill.
-



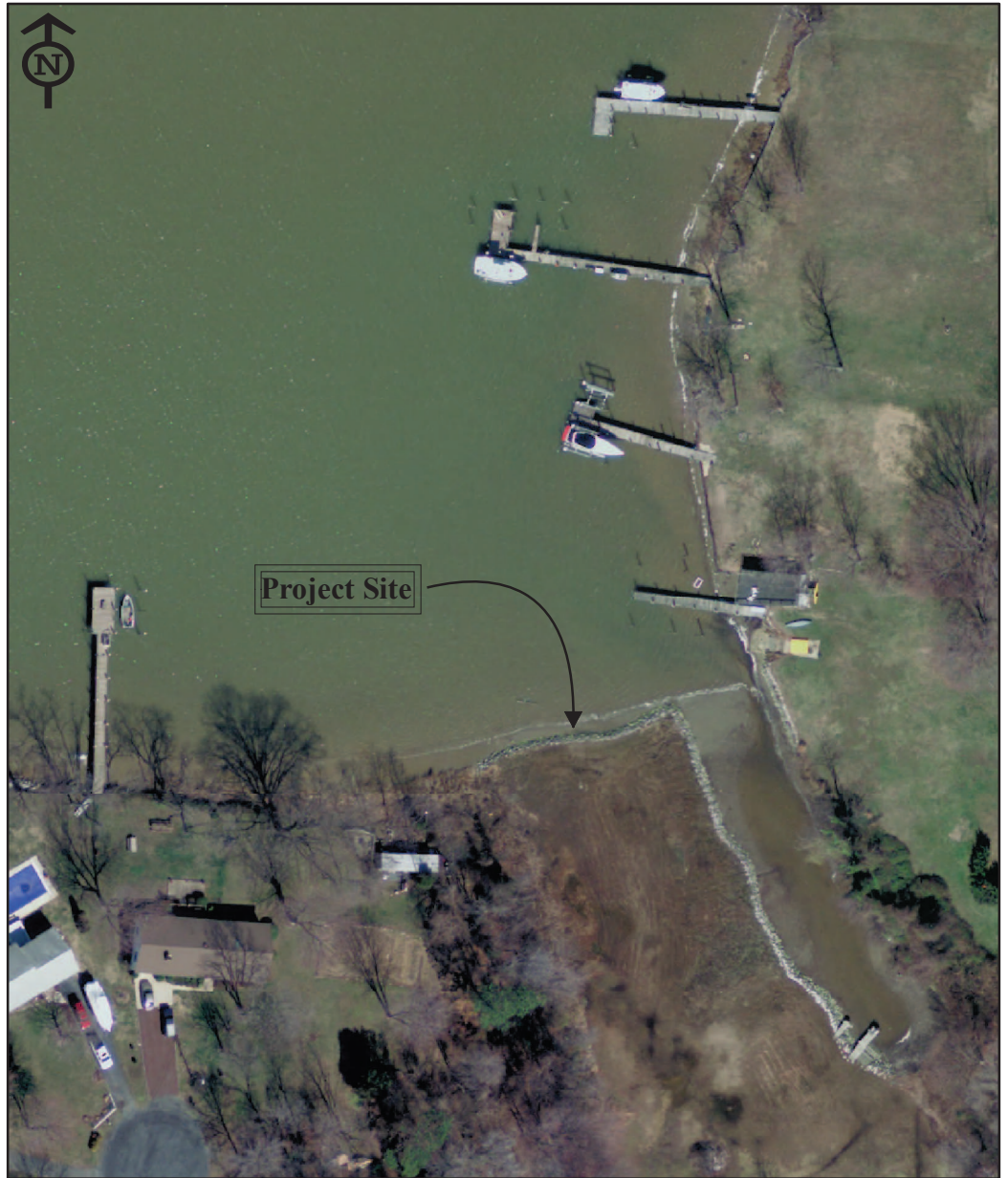
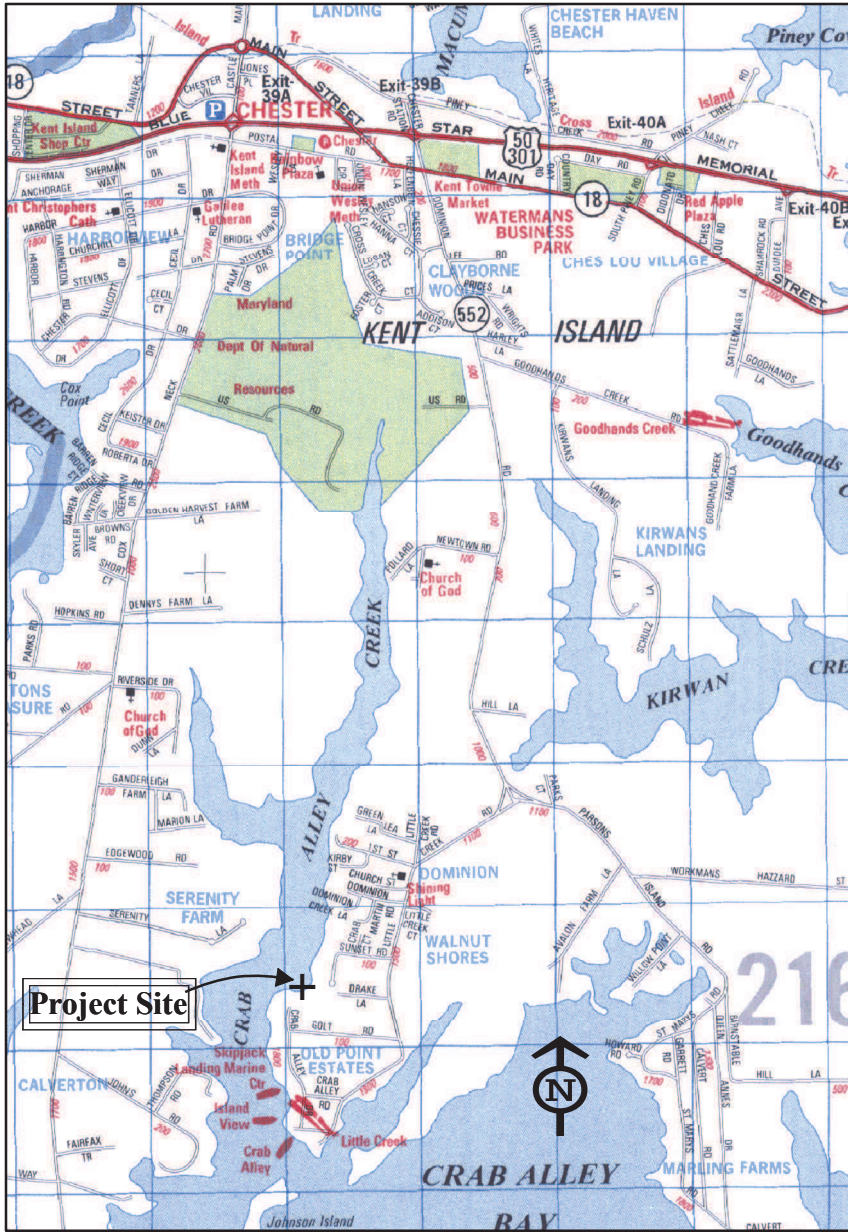

**Vicinity Map & Aerial Photo**

Project: [INSERT TYPE OF PROJECT]

Proposed Project for:  
 Applicant NAME  
 Mailing Address, Town, County, State, Zip Code

NOTES

DATE, Page X of Y

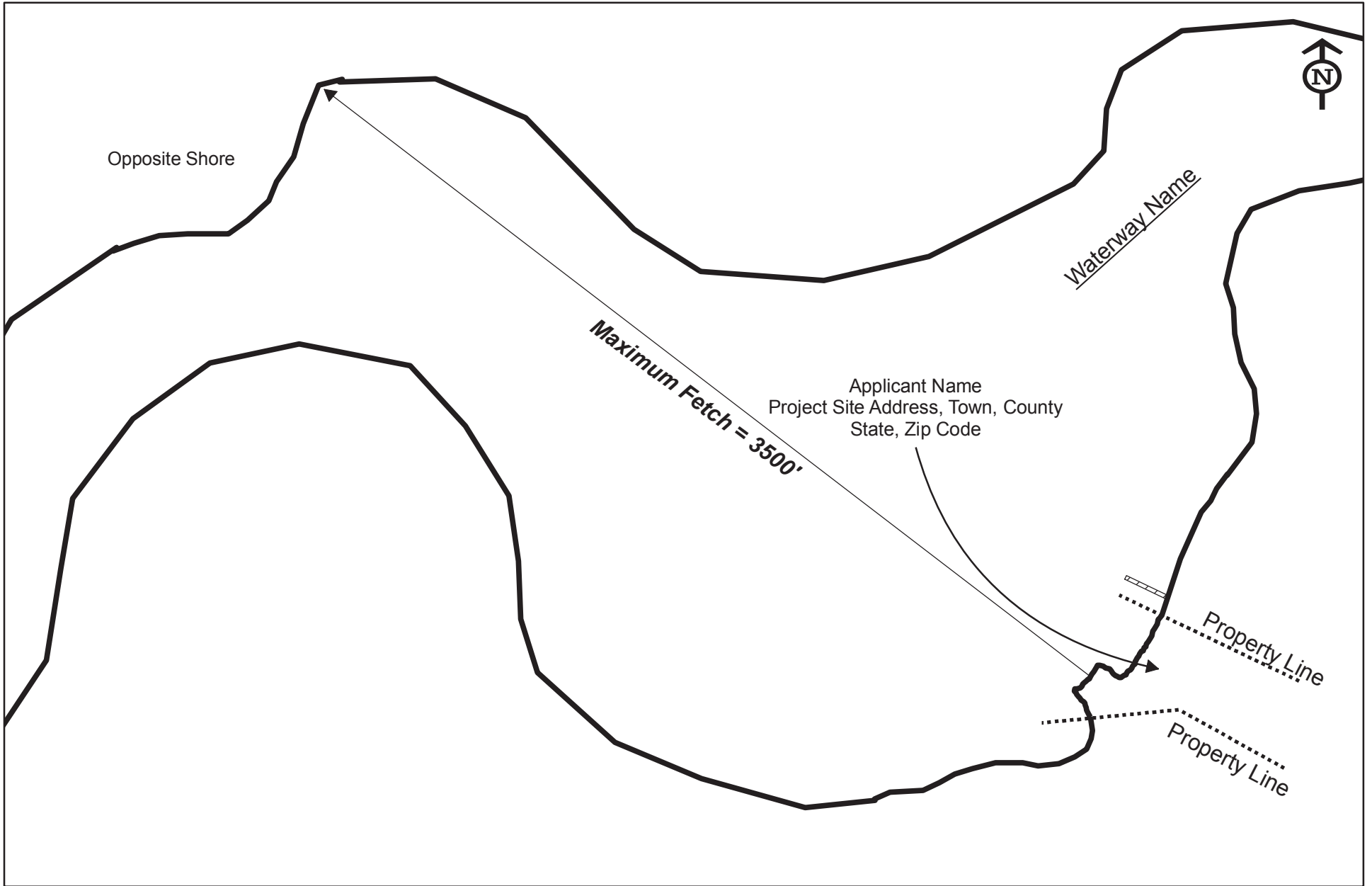

**Project Vicinity Conditions**

Project: Living Shoreline



1 inch = 500 feet

PROJECT NOTES

Proposed Project for:

Applicant NAME

Mailing Address, Town, County, State, Zip Code

DATE, Page X of Y





Waterway Name  
← EBB  
→ FLOE

Maximum Fetch = 3500'

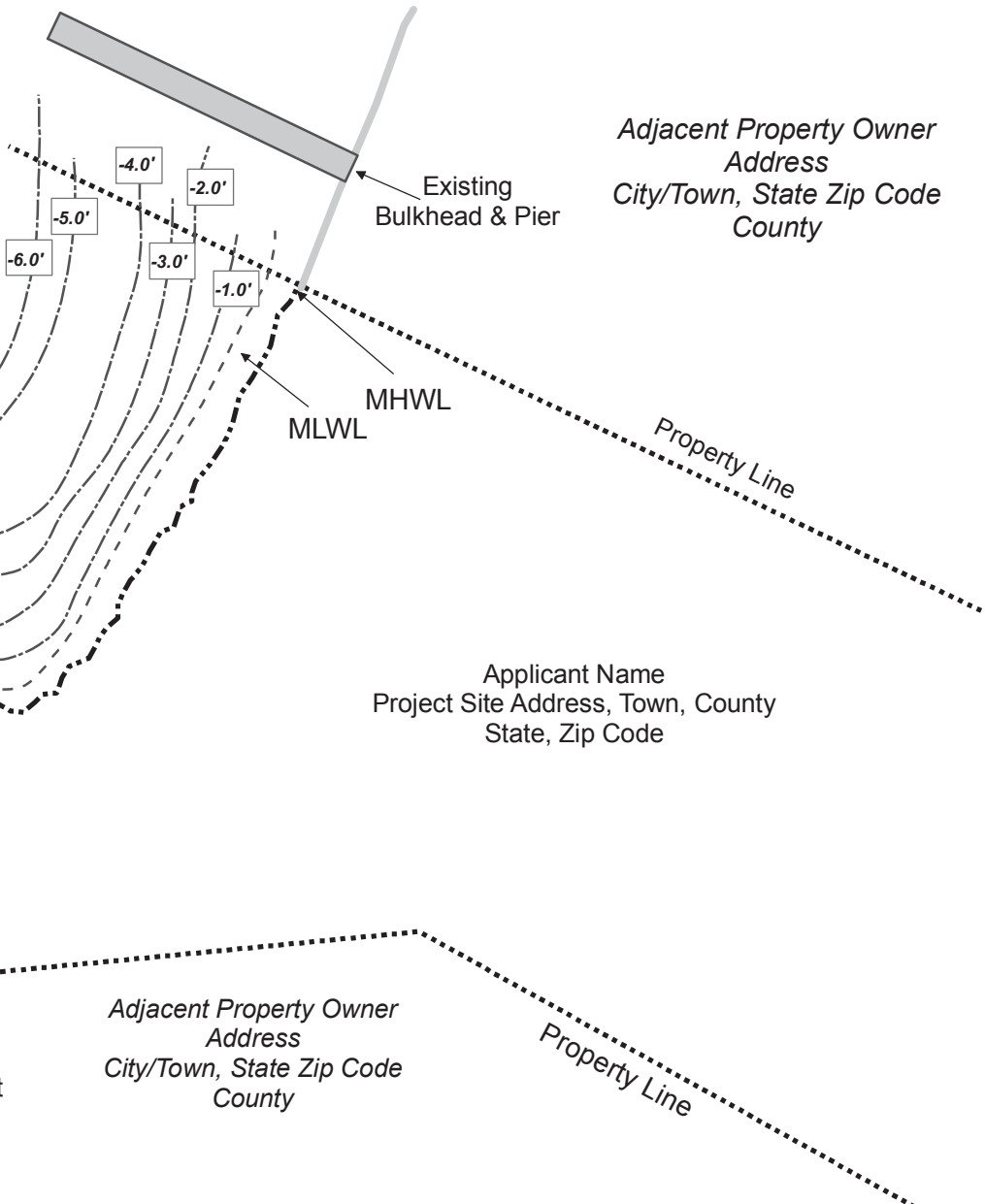

Water depths referenced to mean low water (MLW = 0.0')

### Existing Conditions

Project: Living Shoreline



1 inch = 100 feet

### PROJECT NOTES

Proposed Project for:  
Applicant NAME  
Mailing Address, Town, County, State, Zip Code

Existing Structure





DATE, Page X of Y



Waterway Name



Legend

-  *Spartina alterniflora*
-  *Spartina patens*
-  Existing Tidal Wetlands
-  Low profile stone sill

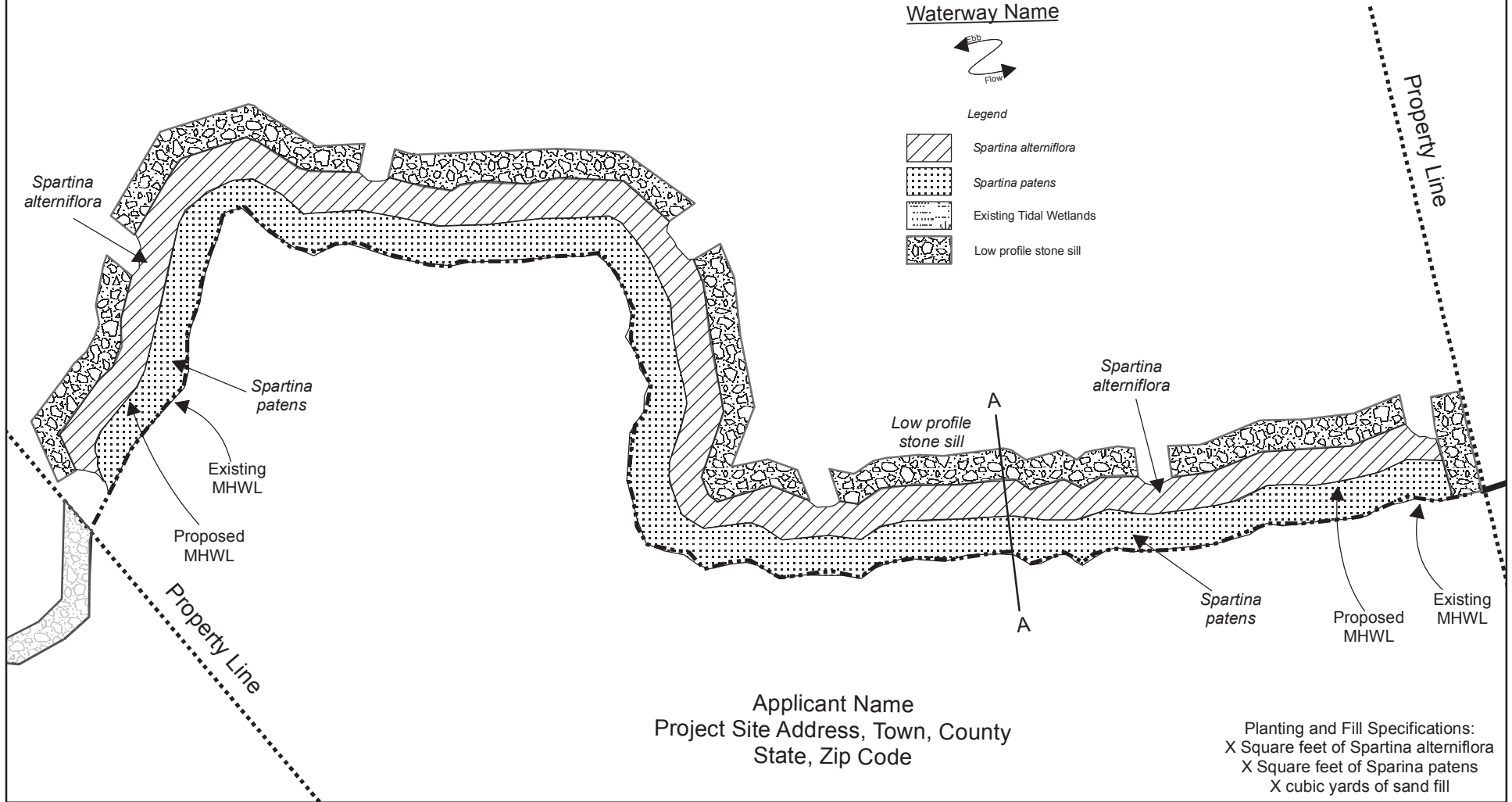

Applicant Name  
 Project Site Address, Town, County  
 State, Zip Code

Planting and Fill Specifications:  
 X Square feet of *Spartina alterniflora*  
 X Square feet of *Spartina patens*  
 X cubic yards of sand fill

**Proposed Conditions**



Project: Living Shoreline



1 inch = 50 feet

**PROJECT NOTES**

Proposed Project for:  
 Applicant NAME  
 Mailing Address, Town, County, State, Zip Code

-  Existing Structure
-  Proposed Structure

**DATE, Page X of Y**

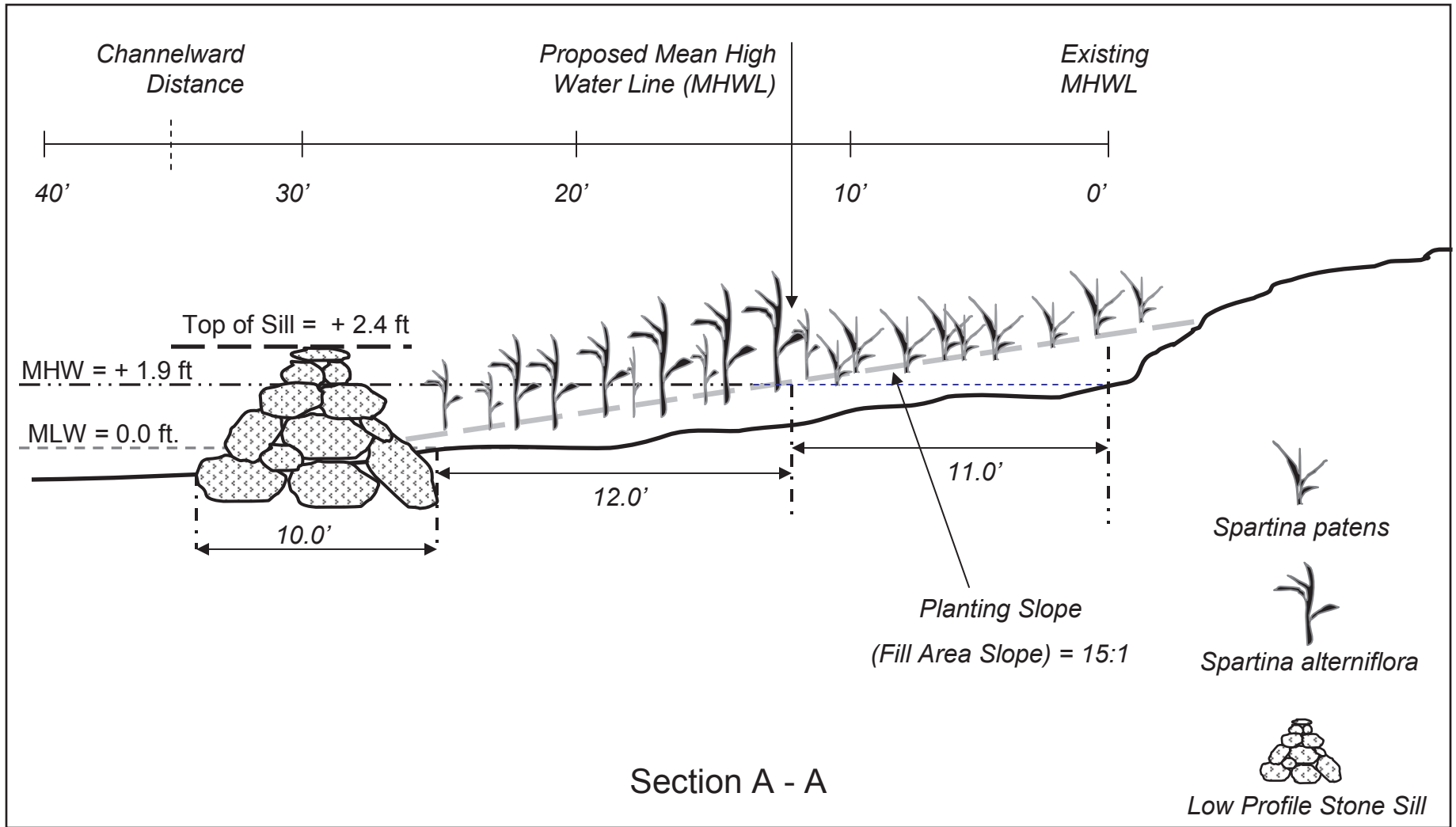

**Project: Living Shoreline**

Proposed Project Cross-section for:  
 Applicant Name  
 Mailing Address, Town, County, State

*Notes:*

Maximum Channelward Distance; Amount of Clean Sand Fill (cubic yds.), Amount of Planting Area (Sq Ft.) for both low marsh (*S. alterniflora*) and high marsh (*S. patens*), Slope of planting area; number of plants; Marsh maintenance plan (draft)

DATE, Page X of Y

Top of Sill = + 2.4 ft

MHW = + 1.9 ft

MLW = 0.0 ft.

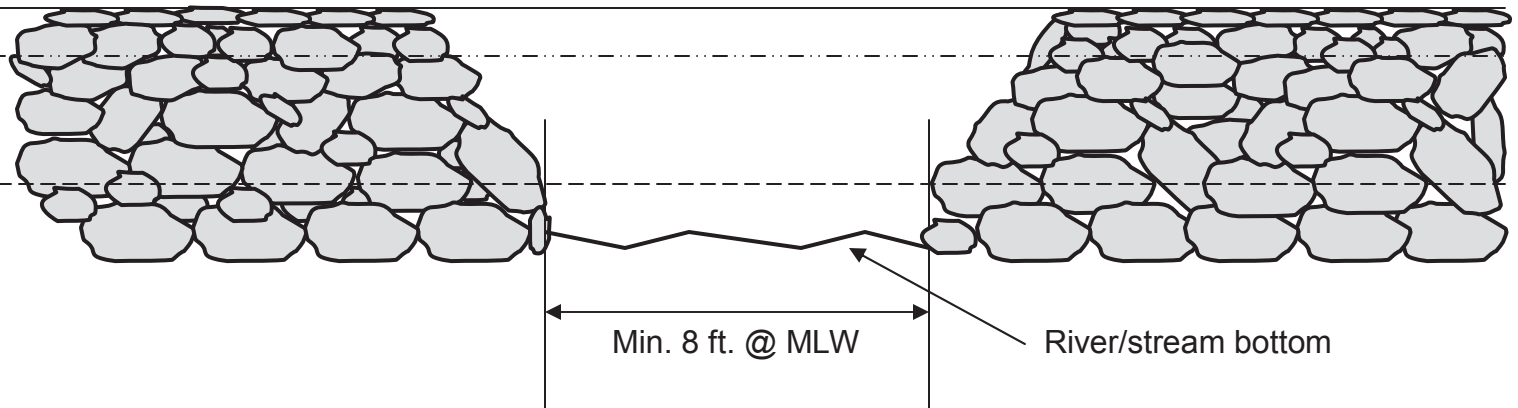

Cross-Section: Typical Sill Opening



*Low Profile Stone Sill*

**Project: Living Shoreline**

Notes: Bottom of sill opening below the MLWL

Proposed Project Cross-section for:  
Applicant Name  
Mailing Address, Town, County, State

DATE, Page X of Y

**WETLANDS AND WATERWAYS PROGRAM  
TIDAL WETLAND APPLICATION GUIDELINES**

**PROPOSED DREDGING PROJECT**

**\*These plan guidelines should only be used for private homeowner dredging projects which only require the ABBREVIATED JOINT FEDERAL / STATE APPLICATION FOR THE ALTERATION OF ANY TIDAL WETLAND AND/OR TIDAL WATERS IN MARYLAND**

Check list outlines the minimum required information for a proposed project; additional information may required based on the project and/or the applicant's project site. Applicants are encouraged to schedule a pre-application meeting to answer questions, discuss the applicant's site, discuss the proposed project, and determine if any additional information/plan sheets are required due to the uniqueness of the applicant's site.

Requires application processing fee

**\*Reference the fee guidelines and tables to determine appropriate application review fees.**

**GENERAL PLAN REQUIREMENTS**

---

Plan sheets should be on 8.5" x 11" paper, black and white, and single sided; Plans are to be legible and not cluttered; usable written or visual scale no smaller than 1" = 50' on proposed plan sheets and a usable written or visual scale no smaller than 1" = 100' on existing plan sheets. All plan notes should be placed at the bottom of the page or on a separate page. The plan sheets should be numbered to reference the plan sheet in relation to the total number of plan sheets i.e. Page 1 of 3, Page 2 of 3, etc.

---

**VICINITY MAP & AERIAL PHOTO PLAN SHEET**

---

Plan sheets should be on 8.5" x 11" paper, black and white, and single sided; Plans are to be legible and not cluttered; All plan notes should be placed at the bottom of the page or on a separate page. The plan sheets should be numbered to reference the plan sheet in relation to the total number of plan sheets i.e. Page 1 of 3, Page 2 of 3, etc.

---

Plan sheet should include the type of projects proposed by applicant i.e. dredging.

---

Plan sheet should include the name of the applicant(s) and mailing address including the town/city, county, state, and zip code.

---

Vicinity map and aerial photo should be sized to clearly depict the project site and surround area, but each map should no smaller than 4" by 4" in size.

---

Vicinity map should include a North arrow and be scaled to clearly show project site, general location on the waterway, the immediate surrounding area.

---

Aerial photograph should be no more than 10 years old from date of application.

---

Aerial photograph should, at a minimum, show the proposed project site (clearly marked) with any existing structures and the adjacent property owners' property with any existing structures.

---

## EXISTING CONDITION PLAN SHEET(S)

---

- Plan sheets should be on 8.5" x 11" paper, black and white, and single sided; Plans are to be legible and not cluttered; usable written or visual scale no smaller than 1" = 100' on existing plan sheets. All plan notes should be placed at the bottom of the page or on a separate page. The plan sheets should be numbered to reference the plan sheet in relation to the total number of plan sheets i.e. Page 1 of 3, Page 2 of 3, etc.

---

  - Plan sheet should include the type of projects proposed by applicant i.e. dredging.

---

  - Plan sheet should include the name of the applicant(s) and mailing address including the town/city, county, state, and zip code.

---

  - Plan view should include the Mean High Water Line (MHWL) and the Mean Low Water Line (MLWL; referenced to 0.0 feet).

---

  - Plan view should include the name of the waterway, North arrow, and direction of ebb/flow tide.

---

  - Plan view should include the property lines (labeled) extended channelward.

---

  - Plan view should include any marked or unmarked channels within the waterway and distance to the nearest edge of the channel.

---

  - Plan view should include water depths marked as either contours or spot depths extending to the edge of the marked or unmarked channel.

---

  - Plan view should depict all existing structures channelward of the Mean High Water Line (MHWL), including shoreline erosion control structures, located at the applicant's project site.

---

  - Plan view should include the applicant's property and directly adjacent riparian properties clearly labeled with their name, site address, town/city, county, state, and zip code.

---

  - Plan view should depict all existing structures channelward of the Mean High Water Line (MHWL), including shoreline erosion control structures, on the adjacent riparian properties.
- 

## PROPOSED CONDITION PLAN SHEET(S)

---

- Plan sheets should be on 8.5" x 11" paper, black and white, and single sided; Plans are to be legible and not cluttered; usable written or visual scale no smaller than 1" = 50' on proposed plan sheets. All plan notes should be placed at the bottom of the page or on a separate page. The plan sheets should be numbered to reference the plan sheet in relation to the total number of plan sheets i.e. Page 1 of 3, Page 2 of 3, etc.

---

  - Plan sheet should include the type of projects proposed by applicant i.e. dredging.

---

  - Plan sheet should include the name of the applicant(s) and mailing address including the town/city, county, state, and zip code.

---

  - Plan view should include the Mean High Water Line (MHWL) and the Mean Low Water Line (MLWL; referenced to 0.0 feet). *If the MHWL or the MLWL are to be altered during construction the proposed MHWL and MLWL should also be labeled.*

---

  - Plan view should include water depths marked as either contours or spot depths.
-



## PROPOSED CONDITION PLAN SHEET(S) (CONTINUED)

---

- Plan view should include the name of the waterway, North arrow, and direction of ebb/flow tide.
  - Plan view should include the property lines (labeled) extended channelward where dredging will occur close to the property lines.
  - Plan view should depict the measurements (width and length) of the proposed dredge area.
  - Plan notes should detail the total square footage of the proposed dredge area, the maximum proposed dredging depth, and the total cubic yards of material proposed to be removed.
- 

## CROSS-SECTION PLAN SHEET(S)

---

- Plan sheets should be on 8.5" x 11" paper, black and white, and single sided; Plans are to be legible and not cluttered. All plan notes should be placed at the bottom of the page or on a separate page. The plan sheets should be numbered to reference the plan sheet in relation to the total number of plan sheets i.e. Page 1 of 3, Page 2 of 3, etc.
  - Plan sheet should include the type of projects proposed by applicant i.e. dredging.
  - Plan sheet should include the name of the applicant(s) and mailing address including the town/city, county, state, and zip code.
  - Cross-section(s) should depict the entire area to be dredged and accurately show the existing bottom elevation and the proposed bottom elevation.
  - Cross-section(s) should depict Mean Low Water (MLWL; referenced to 0.0 feet) and corresponding water depths to the proposed dredging depth.
  - Plan notes should detail the total square footage of the proposed dredge area, the maximum proposed dredging depth, and the total cubic yards of material proposed to be removed.
  - Plan notes should list the name and address of the MDE approved dredge disposal site. The method of transport to be used for the material i.e. water tight trucks, barge, etc.
  - Cross-Section views should include the Mean High Water (MHW), the Mean Low Water (MLW; referenced to 0.0 feet), and top of bank. Example: MLW = 0.0', MHW = + 1.9', + 4.0' Top of Bank.
-

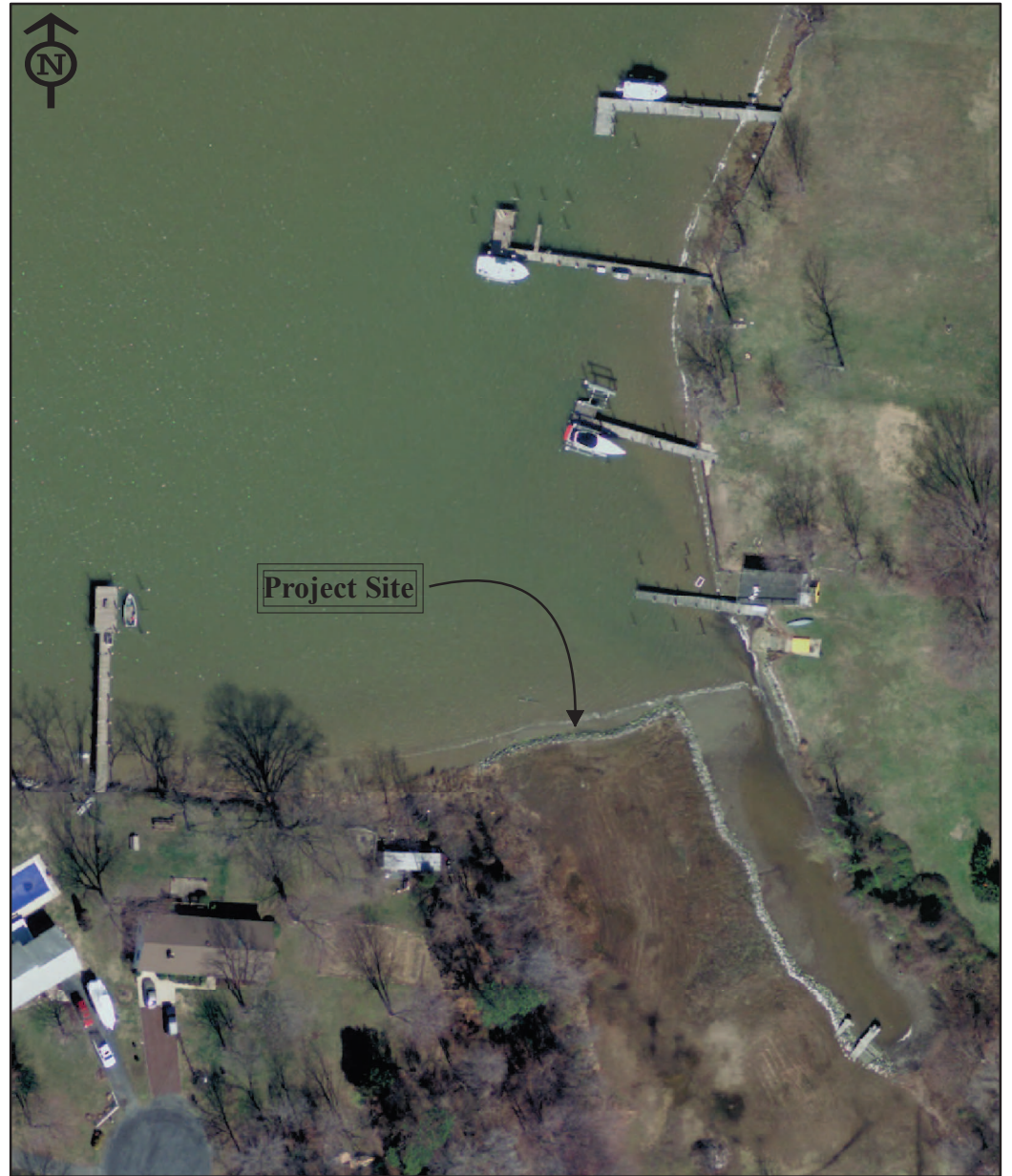
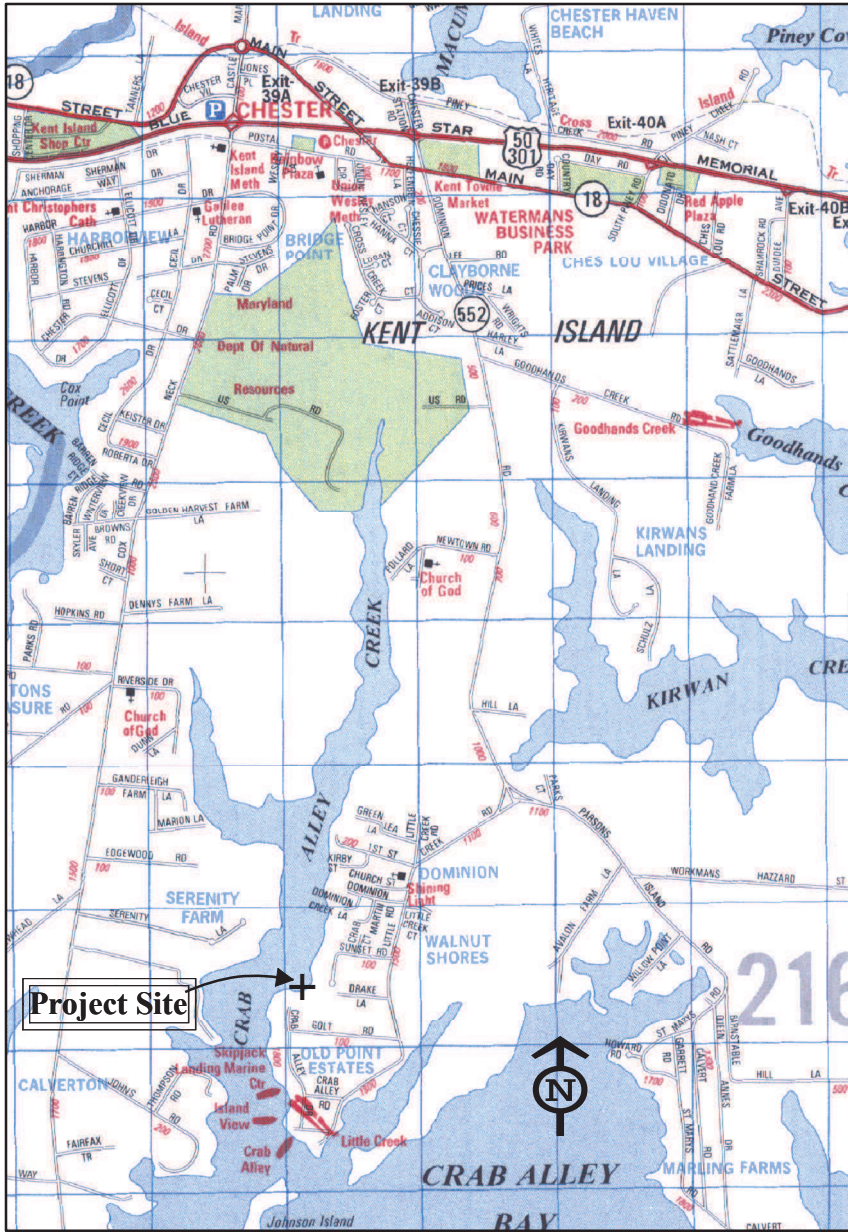

**Vicinity Map & Aerial Photo**

Project: [INSERT TYPE OF PROJECT]

Proposed Project for:  
 Applicant NAME  
 Mailing Address, Town, County, State, Zip Code

NOTES

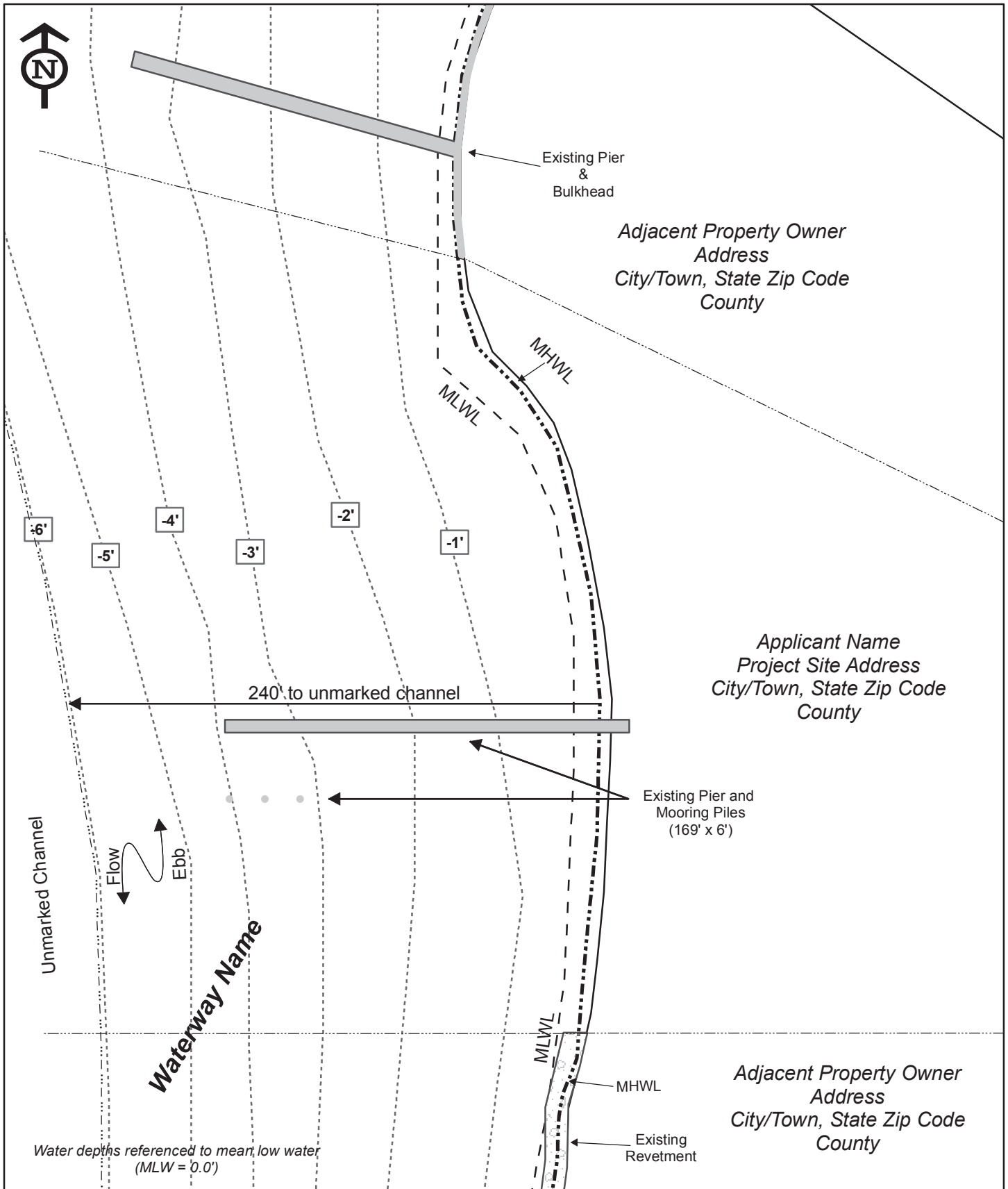

**Existing Conditions**

Project: Dredging  
 Proposed Project for:  
 Applicant NAME  
 Mailing Address, Town, County, State, Zip Code



1 inch = 60 feet

**PROJECT NOTES:**

● Existing Structure

DATE, Page X of Y





**Waterway Name**

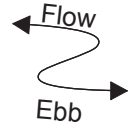

-5'

-4'

-3'

-2'

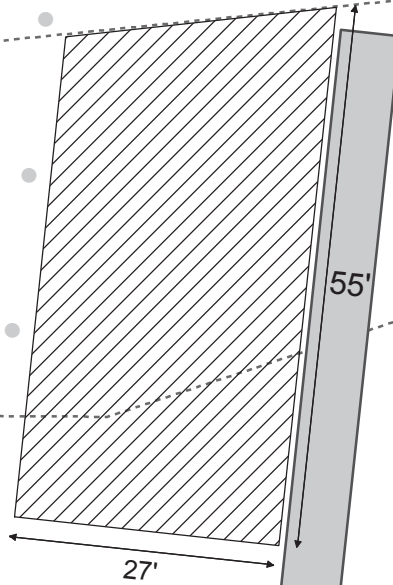

Proposed Dredging Area  
Maximum Dredging Depth -4.0 ft @ MLW  
~ 1485 square feet  
~ 80 Cubic yards of Material

Water depths referenced to mean low water  
(MLW = 0.0')

**Proposed Conditions**

Project: Dredging

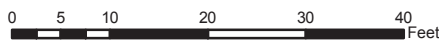

Proposed Project for:  
Applicant NAME

Mailing Address, Town, County, State, Zip Code



1 inch = 20 feet

**PROJECT NOTES:**

-  Existing Structure
-  Proposed Structure

DATE, Page X of Y

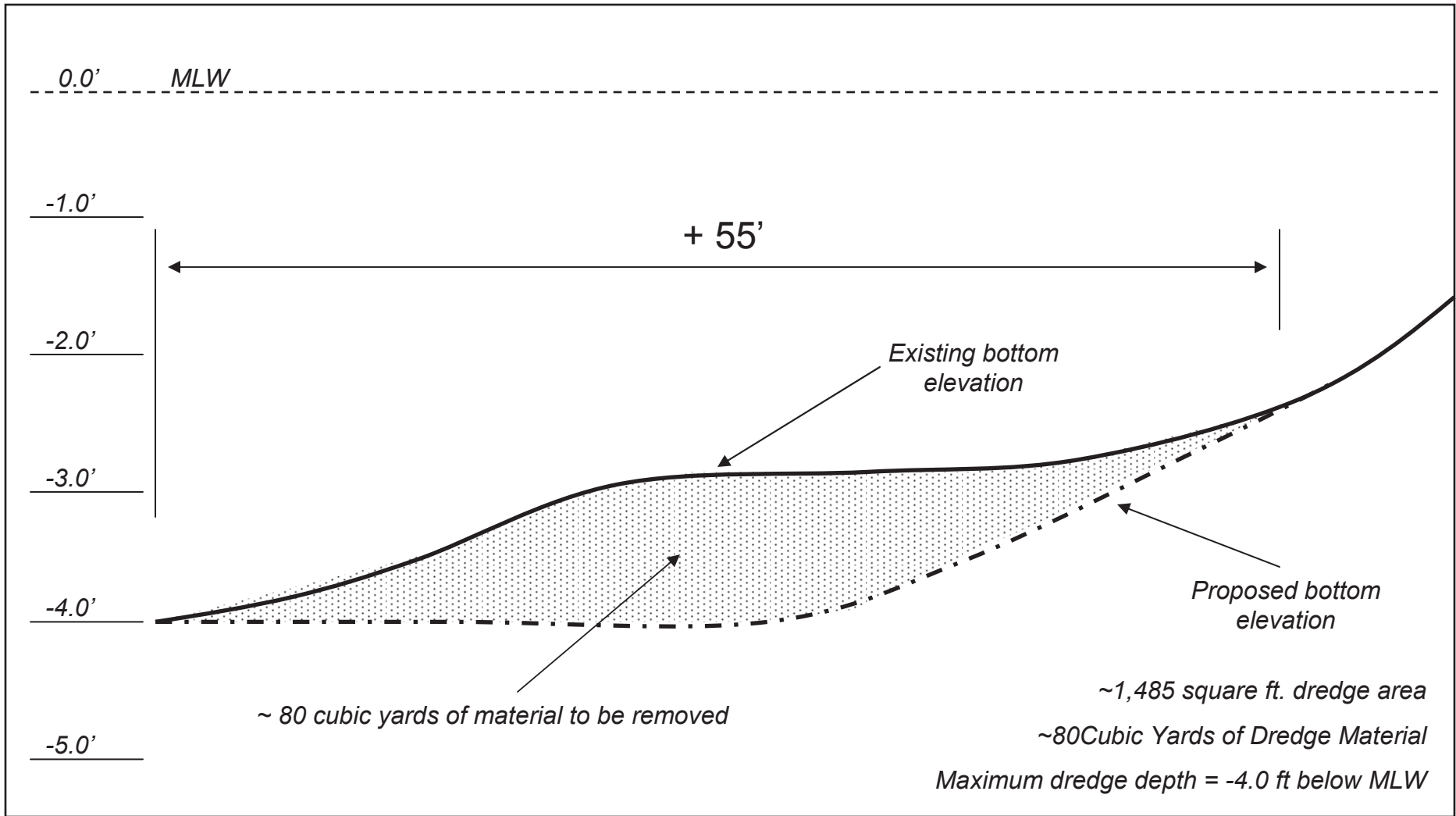

**Project: Minor Dredging**

PROJECT NOTES:  
 Method of transport  
 Address of Dredge Disposal Site

Proposed Project Cross-section for:  
 Applicant Name  
 Mailing Address, Town, County, State

DATE Page X of Y